

DO 9406

INSTRUCTIONS MANUAL

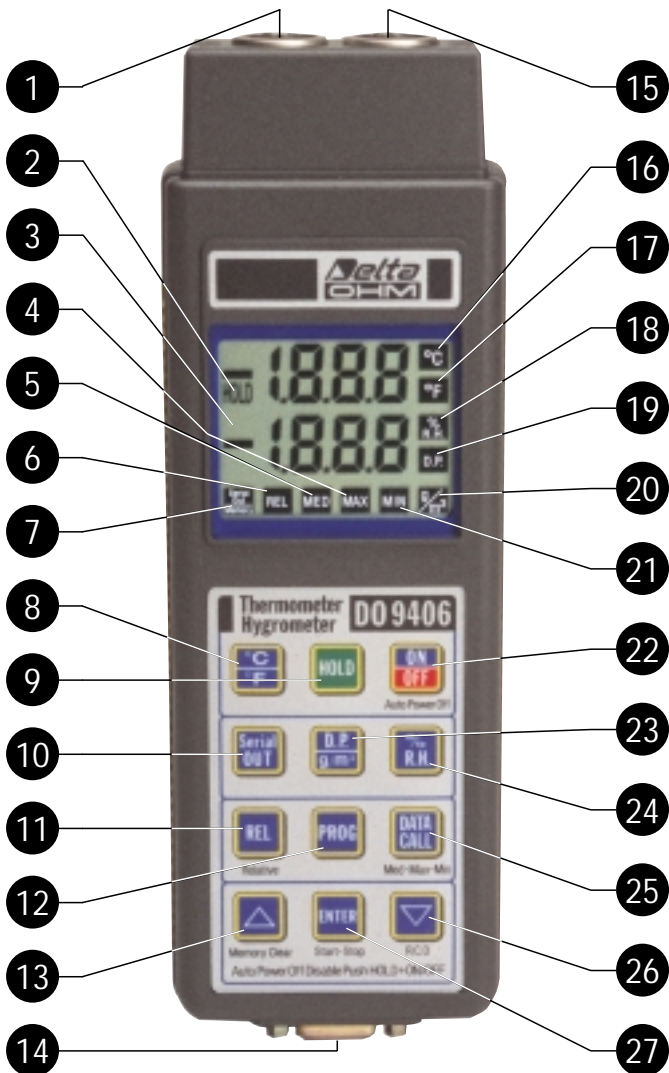

DO 9406



DO 9406

DO 9406 PORTABLE THERMOMETER - HYGROMETER
DATA - LOGGER

ENGLISH

-
1. Input A
 2. Hold, the symbol indicates that the Hold key has been pressed
 3. Battery symbol
 4. The display shows the maximum value
 5. The display shows the mean value
 6. The display shows the relative value
 7. Depending on the function chosen, the symbol indicates that the RS232C function is switched on or that the instrument is storing.
 8. Key for selecting temperature measurement in °C or °F.
 9. Hold key for blocking the reading
 10. Key for selecting the SERIAL output function
 11. Key for taking relative measurements
 12. Key for selecting the various programs
 13. When enabled, the key increases the values shown on the display
 14. Output for RS232C (SUB D male 9-pole)
 15. Input B
 16. The temperature measurement is in °C
 17. The temperature measurement is in °F
 18. The measurement is in % relative humidity
 19. The measurement indicated is the dew point (D.P.)
 20. The measurement indicated is in grams of water per m³ of air (g/m³)
 21. The display shows the minimum value
 22. Key for switching the instrument on and off
 23. Key for selecting measurement in D.P. (dew point) or g/m³
 24. Key for selecting % relative humidity measurement
 25. When pressed in sequence the key indicates the MAX, MIN and MEAN value
 26. When enabled, the key decreases the value shown on the display
 27. The key has various functions: it starts and stops storage, confirms the set parameters.
-

KEY

SYMBOLS LIT BESIDES
THE NUMBERS

DESCRIPTION



All the symbols are lit for a few seconds after pressing the ON/OFF key. Complete display

ON/OFF key. Press this key repeatedly to switch the instrument on or off.

The instrument has a cut-out system (Auto Power Off) which switches off automatically after about 8 minutes.



The  symbol flashes to indicate that Auto Power Off is disabled

HOLD key. If this key is pressed together with the ON/OFF key while switching on, the self cut-out function (Auto Power Off) is deactivated.

The  symbol flashes at a frequency of 1 Hz.

The instrument can be switched off only by pressing the ON/OFF key.



HOLD

When this key is pressed during normal operation the value shown on the display is frozen and the HOLD symbol lights up.

When the key is pressed for the second time the instrument returns to normal operation and the HOLD symbol goes off.

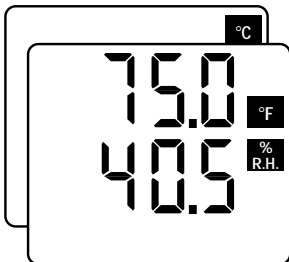

°C/°F key. When the key is pressed the display alternately shows the value of the measurement in °C or °F.

The key is active in the RCD, REL, DATA CALL and HOLD modes. However, in the last of these, the °C/°F key also ends the HOLD status.

KEY

SYMBOLS LIT BESIDES
THE NUMBERS

DESCRIPTION

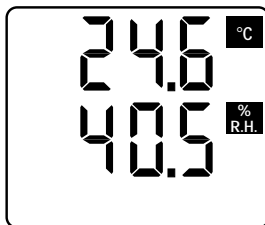

% R.H. key for selecting relative humidity measurement.

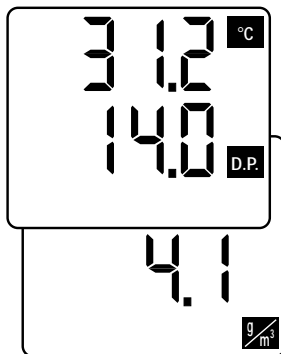

D.P./g/m³ key. When pressed, this key causes the selection at the bottom of the display to change from the D.P. temperature (Dew Point) to the measurement of the absolute humidity expressed in grams of water per cubic metre of air.

The dew point is the temperature at which the cooled air becomes saturated, giving rise to the condensation of the excess vapour. The absolute humidity is calculated by taking as reference the relative humidity at the time and the temperature conditions with reference to the volume of a humid gas at a temperature of 0°C and a pressure of 1013 mbar. The absolute humidity is the weight in grams of the vapour contained in one cubic metre of humid air. Absolute humidity is influenced by pressure. The formula for correcting pressure from 1013 mbar to the real value is the following:

KEY

SYMBOLS LIT BESIDES
THE NUMBERS

DESCRIPTION

$$f'_o(p) = f'_o \frac{p}{1013}$$

where:

$f'_o(p)$ is the absolute humidity of the humid gas at 0°C and pressure p

f'_o is the absolute humidity of the humid gas at 0°C and pressure 1013 mbar

p is the pressure of the gas expressed in mbar.

Example: if the pressure of the gas is 1.2 bar and the instrument indicates a value of 9 g/m³, the following calculation must be made:

$$f'_o(1200) = 9 \frac{1200}{1013} = 10,66 \text{ g/m}^3$$

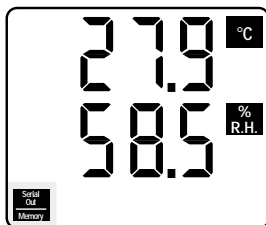

Serial OUT key. The Serial OUT key sends the data being acquired onto the serial line immediately, according to the set programming parameters.

NOTE: The choice of the baud rate influences the speed at which the data are sent onto the serial line.

With a data transmission speed of 300 baud (the character being composed of 10 bit: 1 start bit + 8 character bits + 1 stop bit), the time taken to send 80 characters on the serial line is: $80 / (300/10) = 2.7$ sec. There is therefore a limit on the minimum time that may be set as a function of the

KEY

SYMBOLS LIT BESIDES
THE NUMBERS

DESCRIPTION

baud rate chosen:

BAUD RATE	MINIMUM SETTABLE TIME
300 baud	4 sec.
600 baud	2 sec.
> 600 baud	1 sec.

If a time of less than 4 sec. with a speed of 300 baud is accidentally set during programming, the time is automatically corrected to 4 sec. The Serial Out/Memory symbol flashes during the immediate unloading of data onto the serial line. The instrument does not switch off automatically. All the keys are disabled, preventing the performance of all their functions except the Serial OUT key and the ON/OFF key. When pressed again, the Serial OUT key ends the unloading of data in progress. A report is issued stating the maximum, minimum and mean values.

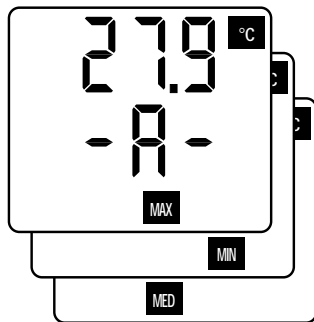

DATA CALL key (Med - Max - Min). When DATA CALL is pressed repeatedly the following three phases are highlighted on the display:

Phase 1:

The max., min. and mean temperature values of input A appear at the top of the display; the message - A - appears at the bottom, indicating Input A.

KEY

SYMBOLS LIT BESIDES
THE NUMBERS

DESCRIPTION

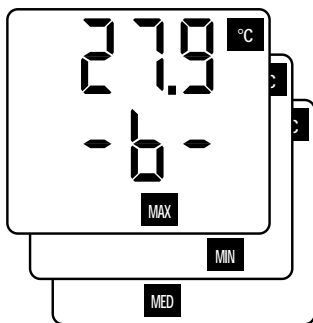
**Phase 2:**

The max., min. and mean temperature values of input B appear at the top of the display; the message - b - appears at the bottom, indicating Input B.

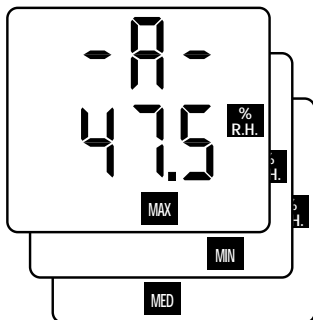
**Phase 3:**

The max., min and mean relative humidity, dew point or absolute humidity values at input A (depending on the selection made) appear at the bottom of the screen; the message - A - appears at the top, indicating Input A. When the DATA CALL function is active, the MAX, MIN and MED symbols are activated one at a time to confirm the value shown on the display.

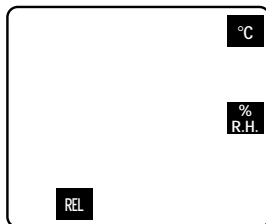

The REL (Relative) key allows you to display or store relative values or send them immediately onto the serial line. The values for comparison are stored at the precise moment in which the key is pressed.

Data may be stored when the REL button is active.

When unloading relative data

KEY

DESCRIPTION

(REL function active) onto the serial line, immediately or from the memory of the instrument, at the end of the data a report will be provided giving the maximum, minimum and mean relative values and the reference values on which the calculation of the relative values was based.



RCD

▼ key (RCD sub-function). During programming this key is used to decrease the value of the parameter being considered. In normal mode the sub-function RCD calculates and stores the maximum, minimum and mean values. When pressed repeatedly the ▼ / RCD key starts and stops the Record function for calculating the max., min. and mean values. When the ▼ / RCD key is held down the instrument emits a short beep followed by a long one. This confirms that the max., min. and mean values stored previously are being erased from the memory and a new series of recordings is started which will be used as the basis on which to calculate and store new max., min. and mean values.

During ▼ / RCD mode the Auto Power Off function is disabled and the ☐ symbol flashes at a frequency of 2 Hz.



▲ key. During programming this key is used to increase the value of the parameter being considered. When this key is pressed in P1, all the data stored are erased (Memory Clear).



ENTER key (Start - Stop sub-function). During programming this key is used both to enter programming and to confirm the value of the parameter considered. In normal mode the ENTER key as Start - Stop sub-function is used alternatively to start or stop storage of a new block of data to be kept in the memory of the instrument. Data storage is performed at the rate set during programming of step P2.

The data stored between one start and the following stop form a block.

Different blocks can thus be formed, all ending (during unloading) with the report giving the maximum, minimum and mean values.

The Serial Out/Memory symbol remains lit for the whole period. The Auto Power Off function is active and the instrument switches itself off after about 8 minutes of inactivity. It is restarted automatically by the clock interrupt control which reactivates the instrument for only the time needed for

KEY**DESCRIPTION**

all the acquisition and storage operations.

Once this has been done the instrument switches itself off again.

During this phase the instrument is apparently off, but it is active in operative mode. If the Serial Out/Memory symbol lights up when switching on the instrument with the ON/OFF key, this means that the instrument is in storage status.

In this stage the Serial OUT and PROG keys are not enabled. When this operative mode is deactivated the Serial Out/Memory symbol is not lit.

Memory DUMP Function

The DUMP function allows unloading of the data stored in the internal memory of the instrument. The total memory capacity available is 512 Kbyte, with the possibility of storing more than 30,000 recordings.

Access to this function is obtained by launching program P1 on the display and pressing the ENTER key. In this way the data are unloaded onto the serial line, the message P1 appears at the top of the display throughout the duration of the dumping process.

During this phase the instrument does not switch itself off (Auto Power Off is disabled). When the ENTER key is pressed, data unloading is stopped for a moment.

At this point there are two possible operative modes. By pressing the PROG key the current DUMP is interrupted and you return to normal operation. If instead the ENTER key is pressed again, data unloading is continued. The message P1 remains at the top of the display throughout the duration of the dumping process. At the end of each block a report is issued giving the maximum, minimum and mean values calculated on the block.

At the end of Dumping the instrument returns to normal function.

During the DUMP phase the instrument does not switch off automatically, all the key functions are disabled except the ENTER key and the ON/OFF key.

NOTES: - The block is defined at the time of storage as a group of consecutive recordings. The first interruption in storage ends and determines the block.

KEY

SYMBOLS LIT BESIDES
THE NUMBERS

DESCRIPTION



Programming of the DO 9406 is activated by pressing the PROG key. The message P0 appears at the top of the display indicating that the parameter P0 is being programmed.

By continuing to press the PROG key the messages P1, P2, P3, P4, P5, P6, P7, P8, P9, P10, P11, P12, P0, etc. are displayed.

Press the ENTER key on one of the points just described to activate programming of the desired parameter.

**- P0 -**

When ENTER is pressed with P0 on the display, the instrument returns to normal operating mode.

**- P1 -**

When ENTER is pressed with P1 on the display, the data stored in the memory of the instrument are unloaded. At the end the instrument automatically returns to normal operating mode.



When the ▲ key, MEMORY CLEAR sub-command, is pressed with P1 on the display, all the stored data are erased.

**- P2 -**

When ENTER is pressed with P2 on the display, the storage time parameter may be modified.

This parameter is used for the following two functions:

KEY**SYMBOLS LIT BESIDES
THE NUMBERS****DESCRIPTION**

1. Logging time, or time elapsing between two consecutive data storages in the memory.

2. Data dump interval, or time elapsing between two immediate data dumps on the serial line.

The ▲ and ▼ keys are used to define the desired intervention time.

At bottom right of the display the instrument indicates the seconds (1 - 59).



At top right of the display the instrument indicates the minutes (1 - 59).





At top left of the display the instrument indicates the hours (1 - 12).

After defining the time, press ENTER to return to normal operation, or press the PROG key to move on to step P3.

In the storage function the thermometer-hygrometer DO 9406 is able to store more than 30,000 acquisitions made at the set interval. The time taken to fill the memory completely is a function of the recording interval and may be obtained from the following table:

RECORDING INTERVAL	TIME TO FILL THE MEMORY
1 sec	8 hours
1 min	20 days
1 hour	1250 days

KEY	SYMBOLS LIT BESIDES THE NUMBERS	DESCRIPTION
P3+		= set Baud Rate
		<p>In storage status, if the memory is completely filled, the storage function automatically cuts out. FUL appears on the display and remains steady together with the Serial Out/Memory symbol for 8 minutes after which the instrument switches off. Activation of the ENTER key enables you to pass to the normal operation mode.</p> <p>The instrument behaves likewise when its memory is complete and you try to start another stage of data acquisition.</p>
		<p>- P3 -</p> <p>When ENTER is pressed with P3 on the display, the Baud Rate of the RS232C serial transmission may be modified. The ▲ and ▼ keys are used to select the desired value.</p> <p>The possible values are:</p> <ul style="list-style-type: none"> 19.2 = 19200 Baud 9.6 = 9600 Baud 4.8 = 4800 Baud 2.4 = 2400 Baud 1.2 = 1200 Baud 0.6 = 600 Baud 0.3 = 300 Baud <p>Finally press ENTER to return to normal operation, or press the PROG key to move on to step P4.</p>
P4+		= set year
		<p>- P4 -</p> <p>When ENTER is pressed with P4 on the display, the year of the date may be set or changed. The</p>

KEY	SYMBOLS LIT BESIDES THE NUMBERS	DESCRIPTION
		▲ and ▼ keys are used to select the desired year. Then press PROG to move on to step P5.
P5+	 = set month	- P5 - When ENTER is pressed with P5 on the display, the month may be set or changed. The ▲ and ▼ keys are used to select the desired year. Then press PROG to move on to step P6.
P6+	 = set day	- P6 - When ENTER is pressed with P6 on the display, the day may be set or changed. The ▲ and ▼ keys are used to select the desired day. Then press PROG to move on to step P7.
P7+	 = set hours	- P7 - When ENTER is pressed with P7 on the display, the hour may be set or changed. The ▲ and ▼ keys are used to select the desired hour. Then press PROG to move on to step P8.
P8+	 = set minutes	- P8 - When ENTER is pressed with P8 on the display, the minutes may be set or changed. The ▲ and ▼ keys are used to select the desired minutes. Then press ENTER to return to normal operating mode or PROG to move on to step P9. Quitting with the ENTER key updates the internal clock with the date and time just set,

KEY	SYMBOLS LIT BESIDES THE NUMBERS	DESCRIPTION
P9+		= enable/disable self cut-out
		<p>setting the seconds at zero at the time of quitting. Pressing the PROG key moves on to step P9 without updating the internal clock.</p>
		<p>- P9 -</p> <p>When ENTER is pressed with P9 on the display, the instrument enters the program which enables or disables the self cut-out function when it is in storage mode or with a set storage interval higher than or equal to 1 minute. The ▲ and ▼ keys are used to select the value 00 or 01.</p> <p>00 With a set storage interval lower than 1 minute, the instrument does not switch off automatically; it remains always lit.</p> <p>By pressing the ON/OFF key storage stops and the instrument switches off.</p> <p>00 With a set storage interval higher than 1 minute the display switches off automatically after about 8 minutes. At each set storage interval there is a beep and the display switches on for few seconds.</p> <p>By pressing the ON/OFF key the display can be switched on or off; the instrument goes on storing, if you keep it switched on; the display switches off automatically after about 8 minutes.</p> <p>To stop storage, press the</p>

KEY

SYMBOLS LIT BESIDES
THE NUMBERS

DESCRIPTION

ON/OFF key (only if the instrument is off). Press the ENTER key.

01 With a set storage interval lower than 1 minute the instrument does not switch off automatically.

By pressing the ON/OFF key storage is interrupted and the instrument switches off.

01 With a set storage interval higher than 1 minute the display does not switch off automatically; it remains always lit and goes on storing.

By pressing the ON/OFF key the display stops till the next acquisition. Then, it switches on again and remains lit.

To stop storage, press the ENTER key.

The ENTER key is used to return to normal operating mode, while pressing the PROG key moves on to step P10.

P10+  = enable/disable data print

- P10 -

When ENTER is pressed with P10 on the display, complete or reduced printing is enabled or disabled. The ▲ and ▼ keys are used to select the value 00 or 01.

- If the value 00 is programmed, the heading is printed with reduced parameters. Example:

date	time	— B —	— A —
...	...	t ...	t ... % R.H. ...

KEY

SYMBOLS LIT BESIDES
THE NUMBERS

DESCRIPTION

- If the value 01 is programmed, the heading is printed with complete parameters. Example:

DELTA001 D09400 THERMOHYGROMETER

Immediate serial report

DATE	TIME	-- B --	--- A ---	
22/02/97	08:09:17	17.4 °C	21.1 °C	38.3 %
22/02/97	08:09:19	17.4 °C	21.1 °C	38.3 %
22/02/97	08:09:21	17.4 °C	21.2 °C	38.2 %
22/02/97	08:09:23	17.5 °C	21.1 °C	38.3 %
22/02/97	08:09:25	17.5 °C	21.1 °C	38.3 %
22/02/97	08:09:27	17.5 °C	21.1 °C	38.2 %
22/02/97	08:09:29	17.5 °C	21.1 °C	38.2 %

DELTA001 D09400 THERMOHYGROMETER

Remote memory report

DATE	TIME	-- B --	--- A ---	
22/02/97	08:14:12	20.3 °C	23.6 °C	27.4 %
22/02/97	08:14:14	20.2 °C	23.6 °C	27.4 %
22/02/97	08:14:16	20.2 °C	23.6 °C	27.4 %
22/02/97	08:14:18	20.1 °C	23.6 °C	27.4 %
22/02/97	08:14:20	20.1 °C	23.6 °C	27.5 %
22/02/97	08:14:22	20.0 °C	23.5 °C	27.5 %
22/02/97	08:14:24	20.0 °C	23.6 °C	27.6 %

date time — B — — A —
 t ... t ... % R.H. ... D.P.... g/m³...

The ENTER key is used to return to normal operating mode, while pressing the PROG key moves on to step P11.

DELTAOHM D09406 THERMOHYGROMETER

Immediate serial report

DATE	TIME	-- B --		----- A -----			
22/02/97	08:11:19	22.6 °C	22.9 °C	27.6 %	3.4 °C DP	6.16	g/m3
22/02/97	08:11:21	22.4 °C	22.9 °C	27.8 %	3.4 °C DP	6.13	g/m3
22/02/97	08:11:23	22.3 °C	22.9 °C	28.0 %	3.5 °C DP	6.17	g/m3
22/02/97	08:11:25	22.2 °C	22.9 °C	28.0 %	3.5 °C DP	6.15	g/m3
22/02/97	08:11:27	22.0 °C	22.9 °C	27.6 %	3.3 °C DP	6.14	g/m3
22/02/97	08:11:29	21.9 °C	22.6 °C	27.7 %	3.2 °C DP	6.10	g/m3
22/02/97	08:11:31	21.6 °C	22.9 °C	27.7 %	3.3 °C DP	6.13	g/m3

DELTAOHM D09406 THERMOHYGROMETER

Remote memory report

DATE	TIME	-- B --		----- A -----			
22/02/97	08:12:24	25.7 °C	24.1 °C	26.3 %	3.6 °C DP	6.23	g/m3
22/02/97	08:12:26	25.6 °C	24.1 °C	26.2 %	3.5 °C DP	6.21	g/m3
22/02/97	08:12:28	25.4 °C	24.0 °C	26.2 %	3.5 °C DP	6.20	g/m3
22/02/97	08:12:30	25.2 °C	24.1 °C	26.4 %	3.6 °C DP	6.26	g/m3
22/02/97	08:12:32	25.0 °C	24.2 °C	52.2 %	13.6 °C DP	12.46	g/m3
22/02/97	08:12:34	24.7 °C	24.2 °C	62.4 %	21.0 °C DP	19.74	g/m3
22/02/97	08:12:36	24.6 °C	24.4 °C	40.6 %	10.1 °C DP	9.79	g/m3

KEY

SYMBOLS LIT BESIDES
THE NUMBERS

DESCRIPTION

P11+

= enable probe
calibration

- P11 -

When ENTER is pressed with P11 on the display, the program for calibrating **the combined probe** inserted in input A is activated. When program P11 is active the symbols for probe A flash on the display (°C, % R.H.), depending on the parameter selector. With this program the user can calibrate the temperature and humidity probe connected to input A of the

KEY	SYMBOLS LIT BESIDES THE NUMBERS	DESCRIPTION
		<p>instrument.</p> <p>We strongly advise you not to allow calibration to be carried out by people who do not have sufficient skill or technical knowledge, or without suitable equipment for checking the operation. Always work in safe electric conditions. All operations must be carried out in such a way as to avoid contact with live parts. The measuring prods and tools must be suitable for the purpose.</p> <p>To calibrate the temperature probes you need a Pt 100 precision simulator, while you need efficient saturated salts for the relative humidity.</p> <p>During calibration the values are read on the display of the instrument. For calibration see the paragraph on Calibration of the combined temperature and humidity probe.</p> <p>At the end of the calibration procedure, press the ENTER key to return to normal operating mode; the date of calibration of the probe is stored permanently and indicated on the printed report, both immediately and when unloading the stored data at the end of each block. If you quit the calibration program with the ENTER key at a time of less than 1 minute from the moment you entered program P11, the date of calibration is not updated.</p>

KEY	SYMBOLS LIT BESIDES THE NUMBERS	DESCRIPTION
P12+	 enable = instrument calibration	<p data-bbox="650 214 710 234">- P12 -</p> <p data-bbox="650 241 950 371">When ENTER is pressed with P12 on the display, the instrument calibration program is activated. For the DO 9406 there is essentially one calibration:</p> <p data-bbox="650 378 950 426">A) Calibration of the slope of the conversion line.</p> <p data-bbox="671 433 950 509">This calibration is performed by pressing ENTER with P12 on the display.</p> <p data-bbox="671 515 950 591">Calibration is performed using the DELTA OHM TP 870 CAL simulator at input B.</p> <ol data-bbox="650 598 950 755" style="list-style-type: none"> 1. Simulate the temperature corresponding to the full-scale (ex. 100.0°C); check that the same value is shown on the display. Correction is made by means of the ▲ and ▼ keys. <p data-bbox="650 762 950 838">The calibration values are stored by pressing the ENTER key; then return to normal operation mode.</p> <p data-bbox="650 845 950 948">With this final operation all the new calibration values and the date of calibration of the instrument are permanently stored.</p> <p data-bbox="650 982 950 1112">NOTE: The date of calibration is updated only if the ▲ and ▼ keys have been used to correct the calibration values.</p> <p data-bbox="650 1146 950 1273">The calibration date will be indicated on the printout both in immediate mode in the final report and when dumping stored data at the end of each reading block.</p>





PROBE CONNECTION

One or two probes may be connected to the DO 9406 portable hygrometer-thermometer: at input A, the combined probe for measuring humidity and temperature mod. HD 8501S, HD 8501SAT/500, HD 8501SS/500.

These probes have a DIN 5-pole male connector. If they were to be connected by mistake to input B the instrument would indicate **Err** in %R.H., DP, g/m³ and a wrong value in temperature.

At input B the Pt 100 temperature probes may be connected, series TP 870 for immersion, TP 870/C for contact, TP 870/A for air, TP 870/P with a penetration point. These probes have a DIN 8-pole male connector.

SONDE DI TEMPERATURA TEMPERATURE PROBES
SONDES DE TEMPERATURE TEMPERATURSONDE SONDA PARA MEDIDA DE TEMPERATURAS

No. Cod. Best. Nr. Codigo	Descrizione Description Beschreibung Description	Disegno Drawing Dessin Zeichnung Esquema	T Sec.	Temp °C
TP 870	Sonda ad immersione - Immersion probe Sonde à immersion - Eintauchfühler Sonda de Inmersión		3" A	- 60 + 400
TP 870P	Sonda a punta - Penetration probe Sonde à pointe - Eindringfühler Sonda de penetración		3" A	- 60 + 400
TP 870C	Sonda per contatto - Surface probe Sonde à contact - Oberflächenfühler Sonda para superficies		12" C	- 60 + 400
TP 870A	Sonda per aria - Air probe Sonde pour air ou gaz - Luftfühler Sonda de aire		3" B	- 60 + 300

A) Costante di tempo in acqua a 100°C

B) Time constant in water at 100°C

A) Constante du temps dans l'eau à 100°C

B) Zeitkonstante in Wasser bei 100°C

A) Constante de tempo en el agua a 100°C

B) Constante de tempo necessária para alcançar el 63% della variazione di temperatura.

Note: The time constant is the time needed to respond to 63% of the temperature changes.

Note: La constante du temps est le temps nécessaire pour arriver au 63% de la variation de la température.

Hinweis: Die Zeitkonstante wird bei Erreichen von 63% des Temperaturergrünungs abgelesen.

Note: La constante de tempo es el tiempo necesario para alcanzar el 63% del valor final en un cambio rápido de temperatura.

B) Costante di tempo rilevata a contatto di superficie metallica a 200°C

B) Time constant observed with metal surface at 200°C

A) Constante du temps observé à contact avec une surface métallique à 200°C

B) Zeitkonstante bei Berühren einer Oberfläche bei 200°C

B) Constante de tempo medida sobre a superfície metálica a 200°C

C) Costante di tempo in aria a 100°C

B) Time constant in air at 100°C

C) Constante du temps dans l'air à 100°C



C) Zeitkonstante in bewegtem Luft bei 100°C

C) Constante de tempo en el aire a 100°C



*

SONDE DI UMIDITÀ E TEMPERATURA HUMIDITY AND TEMPERATURE PROBES
SONDES DE HUMIDITÉ ET TEMPERATURE FEUCHTIGKEITS UND TEMPERATURSONDE SONDA DE HUMEDAD Y TEMPERATURAS

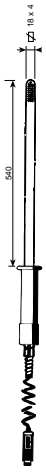
No. Cod. Best. Nr. Codigo	Descrizione Description Beschreibung Description	Disegno Drawing Dessin Zeichnung Esquema	% RH	Temp °C
HD 8501S SS600	Sonda per aria contenitore plastico Air probe, plastic container Sonde pour air ou gaz, conteneur plastique Luftfühler mit Plastikgehäuse Sonda de aire, funda de plástico		5% + 98%	-20°C + +80°C
HD 8501 SA71500	Sonda per granulati contenitore in acciaio inox Sonde pour grains, conteneur inox Getreidefühler, mit inox Gehäuse Sonda para cereales, funda de inox		5% + 98%	-30°C + +130°C
HD 8501 SS600	Sonda a spada contenitore in acciaio inox Sword probe, stainless steel container Sonde épée, conteneur inox Swordspade, mit inox Gehäuse Sonda-espada, funda de inox		5% + 98%	-20°C + +80°C

HOW TO MEASURE

1. Press the ON/OFF key to switch on the instrument.
 - This operation enables the automatic cutout timer.
 - If you wish power supply without automatic interruption, press the HOLD and ON/OFF keys simultaneously. In this case the  symbol flashes. This operation should be carried out before switching the instrument on.
 - When the instrument is switched on all the numbers and symbols light up for a few moments, allowing you to check that all the segments are connected.
2. Check display.
 - After all the segments are lit, the °C or °F unit and the measured temperature value appear at the top of the display. At the bottom of the display, depending on the unit chosen, the % R.H., D.P. or g/m³ symbol will appear together with the respective value.

NOTE: If only one combined temperature and relative humidity probe is connected to input A, the values indicated on the display will be the temperature and humidity values for the sensors in the combined probe. If a combined probe is connected to input A and a temperature probe to input B, the data shown on the display will be as follows: temperature value at the temperature probe in input B and relative humidity at the probe connected to input A.

 - If there is a break in the probe or if it is not properly connected, the broken probe signal appears (Err). In this case check the sensor part and/or the connector.
3. Selection of the measuring unit.

When keys °C, °F, g/m³, D.P., % R.H. are pressed the measurement that is to be taken is selected. Whenever a key is pressed a beep sounds to signal that the operation has been accepted.
4. The instrument is switched off by pressing the ON/OFF key. Because of the Auto Power Off function the instrument may switch itself off during measurements. In this case press the ON/OFF key to switch it on again.
5. Various operations.
 - For operations such as HOLD display, relative measurements, RCD storage, DATA CALL and Serial OUT, see the description of the key function.
 - The instrument usually switches off automatically after 8 minutes of inactivity, with the following few exceptions:
 - a) - Instrument in RCD status.
 - Instrument in Auto Power Off Disabled status.

In these two cases the instrument switches off only by pressing the ON/OFF key. Apart from these two cases the instrument always switches off automatically 8 minutes after the low battery warning has appeared on the display.
 - b) - Instrument during unloading of stored data.

The instrument does not switch off, irrespective of the status of the battery charge.
 - c) - Instrument in storage function.

The instrument switches off automatically 8 minutes after the low battery warning and interrupts storage. When it switches on again there are two possibilities:

 1. If the battery is definitively low even when the instrument switches on again LOU appears

on the display together with the ☐ symbol.

In this status no key is active apart from PROG and ON/OFF. The PROG key (P1+ENTER) enables the activation of the unloading of the stored data even when the battery is low.

2. If the battery has had time to recover and when the instrument switches on its charge seems, even just a little, higher than the minimum value, LOU appears on the display without the ☐ symbol for a short period of time (about 4 seconds), after which the instrument returns to its normal operation; this is to remind the user that the instrument was previously in storage function and that this procedure was interrupted by the low battery warning.
 - The instrument allows the unloading of the stored data through the programme P1+ENTER. The data are transferred directly on serial line through the CP 232 C adapter cable. By using the Xon/Xoff protocol it is possible to unload the data on computer for the control of the data flow:
 - The Xoff character (hex 13) on the serial port stops the current unloading of data.
 - The Xon character (hex11) reactivates the current unloading of data which was interrupted.
 - The unloading of data can be stopped by pressing the ENTER key on the keyboard. It is possible to quit this status and return to normal operation by pressing the PROG key or to reactivate the unloading of data, which was interrupted, by pressing once again the ENTER key on the keyboard.

Measurement with the combined temperature and humidity probe is performed by inserting the probe in the area of which you wish to measure the parameters. Keep the probe far away from elements that may interfere with the measurement such as sources of heat or cold, walls or unexpected draughts. **Reading is almost immediate where there are no sudden heat changes. If there are sudden heat changes you must wait until the probes and the probe container body are at the same temperature, otherwise there is radiation or absorption of heat on the relative humidity sensor. This leads to incorrect measurement, as the temperature influences the relative humidity.**

The same precaution must be taken when taking measurements at both low and high temperatures.

The combined probes HD 8501S, HD 8501SAT/500, HD 8501SS/500 are suitable for measuring temperature, relative humidity and activity of water; **they are not suitable for measuring absolute humidity or for contact measurements.** The relative humidity measurement is expressed as % R.H.

Relative humidity is the ratio between the amount of vapour present in the air considered and the amount that air at the same temperature could contain if it were saturated. Air is defined as saturated when, in determined conditions of temperature, humidity and pressure, it has absorbed the greatest possible amount of vapour. The absolute humidity measure is expressed in g/m^3 . Absolute humidity is calculated by taking as reference the relative humidity at the time and the theoretical temperature conditions with reference to the volume of a humid gas at a temperature $T = 0^\circ\text{C}$ and pressure $P = 1013 \text{ mbar}$.

Absolute humidity is the weight in grams of the vapour contained in one cubic metre of humid air.

Dew point is the temperature at which the cooled air becomes saturated, giving rise to the condensation of the excess vapour.

Temperature measurements with probes in the TP 870 series are performed by introducing the immersion probe to a minimum depth of 60 mm into the liquid in which you want to take the measurement; the sensor is housed in the end of the probe.

To take measurements in air, the probe must be pointed in a transverse direction to the air flow. In both cases, to ensure correct measurement, avoid contact of the probe with the walls.



When taking penetration measurements the tip of the probe must be inserted at a depth of at least 60 mm; the sensor is housed in the end of the probe. When taking measurements on frozen blocks it is convenient to use a mechanical tool to make a cavity in which to insert the pointed probe.

To perform a surface measurement correctly the surface must be flat and smooth and the probe must be perpendicular to the measuring plain.

To obtain a correct measurement, the application of a little heat-conductive paste or a drop of oil (water or solvents must absolutely not be used) helps to improve the response time.

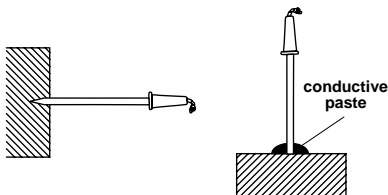

ATTENTION

The use of the keys on this instrument is relatively simple, but care must be taken to avoid setting it by mistake in an undesired mode. Ensure that HOLD, RCD, REL, MAX, MIN, Serial Out/Memory are not displayed during normal operation.

METHOD OF USE

- Avoid touching the humidity and temperature sensor of the combined probe with your hands.
- If the sensor breaks or becomes faulty it may be replaced. In this case the probe must be recalibrated.
- For checking or recalibration, saturated solutions are available which are able to generate different stable levels of humidity
- Do not let the surfaces of the sensor come into contact with sticky surfaces or substances that can corrode or damage the sensor and its polymer.
- For normal applications of the probes in the series HD 8501S... it is advisable to check calibration once a year, for the probe HD 8501 SAT/500 once every 18÷24 months. This operation must be carried out very carefully and scrupulously by skilled personnel, exactly following the calibration instructions.
- Do not use the temperature probes in the series TP 870... in the presence of corrosive gases or liquids; the container in which the sensor is housed is made of stainless steel AISI 316, while the container for the contact probe is of AISI 316 plus silver.
- Do not bend or force the contacts when inserting the connector.
- Do not bend or deform the probes as this could cause irreparable damage.
- Always use the most suitable probe for the measurement to be taken.
- Be careful with the range of use of the probe, **measurements at limit values are possible only for short periods.**
- Above 400°C, avoid violent blows or thermal shock to the temperature probes as these could cause irreparable damage.
- To obtain a reliable temperature measurement, avoid too fast temperature variations.
- Temperature probes for surface measurements must be held in a vertical position with respect to the surface. Apply a drop of oil or heat-conductive paste between the surface and the sensor so as to improve contact and reduce the reading time. Do not use water or solvents to do this.
- Temperature measurements on non-metal surfaces require a great deal of time on account of their low heat conductivity.
- Always clean the probes carefully after use.
- The instrument is resistant to water but it is not watertight and should not therefore be immersed in water. If it should fall into the water, take it out immediately and check that no water has infiltrated.
- The temperature sensor is not insulated from its external casing. Be very careful not to come into contact with live parts (above 48 V) as this could be dangerous not only for the instrument but also for the operator, who **could suffer an electric shock.**
- Avoid taking measurements in the presence of high frequency sources, microwaves or large magnetic fields, as the results would not be very reliable.

LOW BATTERY WARNING AND BATTERY REPLACEMENT

If the battery has used up more than 90% of its charge, or if its voltage has reached the limit value of 7.2 Volts, a beep sounds every 10 seconds and the  symbol appears on the display. In these conditions the battery should be replaced as soon as possible.





AFTER CHANGING THE BATTERY YOU MUST UPDATE THE CLOCK AND THE PARAMETERS P2, P3 ... AND SO ON.

To change the battery turn the instrument retaining screw in an anti-clockwise direction. After replacing it (with an ordinary 9V battery IEC 6LF22) close the instrument, inserting the tag into the slot provided, turn the screw in a clockwise direction.

The stored data will not be lost even if the instrument remains without batteries.



Ensure that the instrument is switched off before changing the battery.

The  symbol appears fixed to indicate that the battery is low. This indication prevails over all the other signals which make use of the  symbol. In RCD function the  symbol flashes at a frequency of 0.25 Hz. In Auto Power Off function the  symbol flashes at a frequency of 0.5 Hz. The flashing of the RCD function prevails over the flashing of Auto Power Off.

FAULTY OPERATION WHEN SWITCHING ON AFTER CHANGING THE BATTERY

Repeat the battery changing procedure, waiting for a few minutes to allow the circuit condenser capacities to be completely discharged, then insert the battery.

WARNING

- If the instrument is not to be used for a long time the battery must be removed.
- If the battery is flat it must be replaced immediately.
- Take steps to avoid leakage of liquid from the battery.
- Use good quality leakproof batteries.

MAINTENANCE

Storage conditions:

- * Temperature: -10 to +50°C.
- * Humidity: less than 90% relative humidity.
- * Do not store the instrument in places where:
 1. There is a high degree of humidity.
 2. The instrument is exposed to direct sunlight.
 3. The instrument is exposed to a source of high temperature.
 4. There are strong vibrations.
 5. There is steam, salt and/or corrosive gas.

The instrument body is made of ABS plastic so it must not be cleaned with solvents which can spoil plastic.

GUARANTEE

This instrument is strictly inspected before being sold. However if there should be any defect due to manufacture and/or transport, apply to the dealer from whom you bought the instrument.

The guarantee period is 2 (two) years from the date of purchase. During this period all defects found by us will be repaired free of charge, **excluding those due to incorrect use, to wear and careless handling. The probes are not covered by the guarantee, as they can be irreparably damaged after only a few minutes of incorrect use.**

SERIAL INTERFACE RS-232C

The DO 9406 is equipped with the standard serial interface RS-232C; it is supplied with the adapter cable CP 232 C. The following signals are available on the SUB D 9-pin male connector of the DO 9406:

PIN	SIGNAL	DESCRIPTION
3	TD	Datum transmitted by the DO 9406
2	RD	Datum received by the DO 9406
5	GND	Reference logic mass

NOTE: The deflector on the connector of the adapter cable CP 232 C must be placed in COMPUTER or PRINT position, according to the chosen connector.

The signals present in pins 2 and 3 are at logic levels compatible with the standard RS-232C.

The transmission parameters with which the instrument is supplied are:

- Baud rate 19200 baud
- Parity None
- No. bits 8
- Stop bit 1

The data transmission speed may be changed by pressing the PROG key on the instrument to alter the set-up parameter P3. The possible baud rates are: 19200, 9600, 4800, 2400, 1200, 600, 300.

The other transmission parameters are fixed.

All the messages reaching and leaving the DO 9406 must be inserted in a "Communication frame" with the following structure:

Record-cr

where:

- Record- constitutes the message
- cr- Carriage Return (ASCII 0D)

HOST COMMANDS

COMMAND

AA	Type of terminal
AG	Firmware Version
AH	Firmware Date
AK	Company
SA	Temp. request
SB	Temp. request
SC	% R.H. request

REPLY

DeltaOhm DO 9406
V. x R. x
dd/mm/yy
DELTA OHM
t A
t B
% R.H.

SD	D.P. request	D.P.
SE	g/m ³ request	g/m ³
SI	Terminal Type	DO 9406
S*		NC
Xoff (Ctr-S)	Stops transmission in progress	
Xon (Ctr-Q)	Resumes transmission in progress	

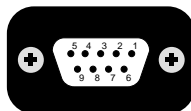
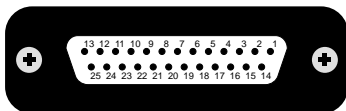
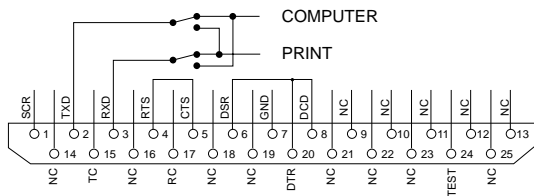
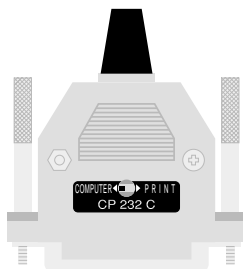

DO 9406 DIAGRAM

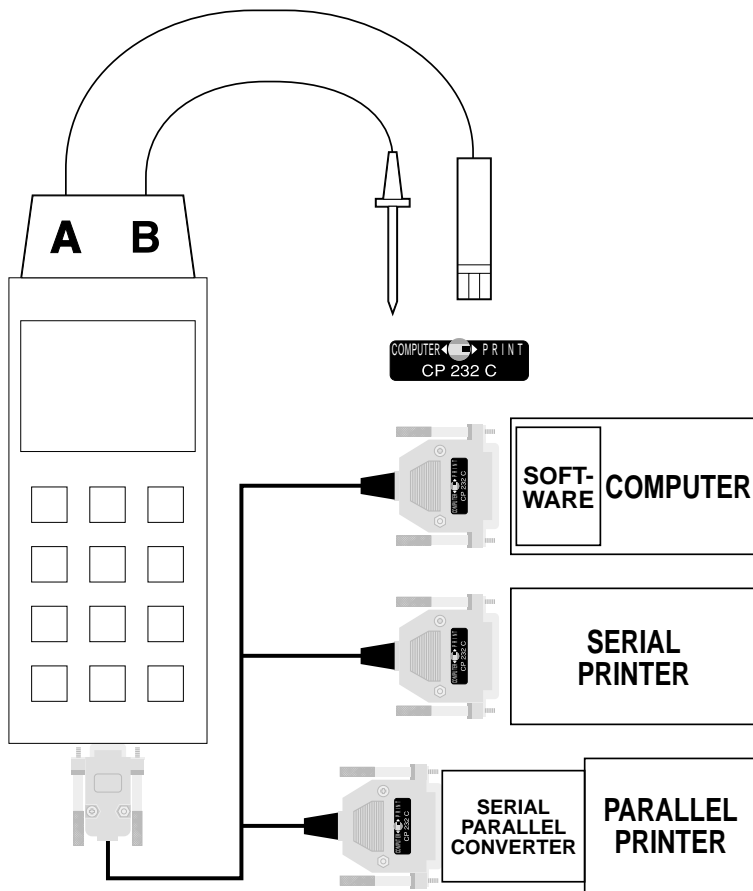

CALIBRATION OF THE COMBINED TEMPERATURE AND HUMIDITY PROBE

A) Instructions for calibration of the RELATIVE HUMIDITY section of combined Relative Humidity / Temperature probes in the series HD 8501S... with saturated solutions of salts of SODIUM CHLORIDE (75.4%), MAGNESIUM CHLORIDE (33%) and LITHIUM CHLORIDE (11.3%) with three calibration points.

Foreword

The procedure for calibrating the probes is quite simple, but in order to achieve correct calibration it is fundamental to know and respect the physical phenomena involved in measuring relative humidity. **We strongly advise you not to have the instrument adjusted by people who are not sufficiently trained or who do not have adequate technical knowledge.**

The calibration sequence with three points is performed in the following order:

- | | |
|-----------------------------|----------------------------------|
| 1 st calibration | solution with 75.4% R.H. (HD 75) |
| 2 nd calibration | solution with 33% R.H. (HD 33) |
| 3 rd calibration | solution with 11.3% R.H. (HD 11) |

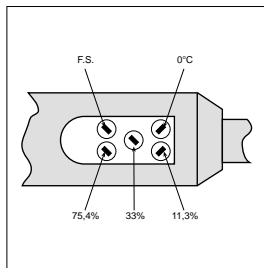

The first calibration point is always 75.4% R.H.

For correct calibration it is very important for the environment temperature to be stable and for both the saturated solution and the probe to be calibrated to be at the same temperature. We recommend 20°C.

Calibration sequence:

1. Unscrew the sensor protection.
2. Screw the perforated cap and its threaded ring nut into place, right down to the base.
3. Open the cap of the 75.4% R.H. saturated solution.
4. Check that **there are no drops of solution** inside the measuring chamber; if there are any, dry

them with absorbent paper.

5. Insert the probe in the container, ensuring that the cap with the probe goes down to the base. The measuring chamber must be perfectly closed, otherwise it will not become saturated. It is fundamental that there be no possibility of air getting in from outside.
6. **Wait 30 minutes.**
7. Open the door of the compartment housing the calibration trimmers using a suitably sized cross-head screwdriver.
8. The probe is connected to the instrument. Switch on the instrument. Ensure that the measurement is stable.
9. Using a small screwdriver, set the calibration trimmer for the value of 75.4% R.H. **The trimmer can rotate through 270°. Do not try to force the stop, as this would break the slot for the screwdriver.** Turn the trimmer until the value indicated by the instrument coincides with the one on the chart corresponding to the temperature of the sensor and of the saturated solution.
10. Ensure that the measurement is stable; wait a few minutes, then go on to calibrate the second point.
11. Take the probe out of the container, close the container with its cap and open the container of the saturated solution with 33% R.H. Check that there are no drops of solution inside; if there are any, dry them with absorbent paper.
12. Insert the probe in the container, ensuring that the probe and the cap go perfectly down to the base. The measuring chamber must be perfectly closed, otherwise it will not reach equilibrium. This is fundamental.
13. **Wait 30 minutes.**
14. Switch on the instrument and ensure that the measurement is stable.
15. Using a small screwdriver, set the calibration trimmer for the value of 33% R.H. until the value indicated by the instrument coincides with the one on the chart corresponding to the temperature of the sensor and of the calibration solution. **The trimmer can rotate through 270°; do not try to force the stop, as this would break the slot for the screwdriver.**
16. Ensure that the measurement is stable; wait a few minutes, then go on to calibrate the third point.
17. Take the probe out of the container, close the container with its cap and open the container of the saturated solution with 11.3% R.H. Check that there are no drops of solution inside; if there are any, dry them with absorbent paper.
18. Insert the probe in the container, ensuring that the probe and the cap go perfectly down to the base. The measuring chamber must be perfectly closed, otherwise it will not become balanced. This is fundamental.
19. **Wait 30 minutes.**
20. Switch on the instrument and ensure that the measurement is stable.
21. Using a small screwdriver, set the calibration trimmer for the value of 11.3% R.H. until the value indicated by the instrument coincides with the one on the chart corresponding to the temperature of the sensor and of the calibration solution.
The trimmer can rotate through 270°; do not try to force the stop, as this would break the slot for the screwdriver.

22. Ensure that the measurement is stable; wait a few minutes. Switch off the instrument, remove the probe from the container. Close the container with its cap.
23. Unscrew the ring nut with the cap, screw on the sensor protection and close the door of the calibration trimmer compartment. This operation concludes calibration.

IMPORTANT NOTES:

- Do not touch the R.H. sensor with your hands.
- The base of the R.H. sensor is made of glass, it breaks very easily.
- **During the entire calibration cycles, work as much as possible at a constant temperature;** plastics are generally bad heat conductors, so it takes some time for them to reach a given temperature and remain stable.
- Temperature influences the humidity measurement.
- If you do not succeed in staying within the calibration values, the possible causes may be the following:
 - A) The sensor is faulty, corroded or broken.
 - B) During calibration the measurement chamber was not perfectly closed, that is air was getting in.
 - C) The saturated solutions used are exhausted, that is there is no more salt, but only a dense liquid; in this state the measurement chamber cannot reach saturation.
- Storage of the saturated solutions:

The saturated solutions must be kept, if possible, at a constant temperature of around 20°C. Avoid leaving the container open, otherwise the lifetime of the solution will be quite short; also, a large number of drops of liquid would form inside the measurement chamber. During transport or air freight, pressures or vacuums may tend to cause the liquid to escape from the balancing hole or from the porous septum of the measurement chamber; if this should occur, dry up the liquid with absorbent paper; even if some drops are lost the solution will still work perfectly for a long time.

**Tolerances For Platinum Resistance Detectors to IEC751(1983)
BS1904(1984) and DIN43760(1980)**

Temp °C	Tolerance									
	CLASS B		CLASS A		1/3 DIN		1/5 DIN		1/10 DIN	
	+/- °C	+/- OHMS	+/- °C	+/- OHMS	+/- °C	+/- OHMS	+/- °C	+/- OHMS	+/- °C	+/- OHMS
-200	1.3	0.56	0.55	0.24	0.44	0.19	0.26	0.11	0.13	0.06
-100	0.8	0.32	0.35	0.14	0.27	0.11	0.16	0.06	0.08	0.03
0	0.3	0.12	0.15	0.06	0.1	0.04	0.06	0.02	0.03	0.01
100	0.8	0.3	0.35	0.13	0.27	0.1	0.16	0.05	0.08	0.03
200	1.3	0.48	0.55	0.2	0.44	0.16	0.26	0.1	0.13	0.05
300	1.8	0.64	0.75	0.27	0.6	0.21	0.36	0.13	0.18	0.06
400	2.3	0.79	0.95	0.33	0.77	0.26	0.46	0.16	0.23	0.08
500	2.8	0.93	1.15	0.38	0.94	0.31	0.56	0.19	0.28	0.09
600	3.3	1.06	1.35	0.43	1.1	0.35	0.66	0.21	0.33	0.1
650	3.6	1.13	1.45	0.46	1.2	0.38	0.72	0.23	0.36	0.11

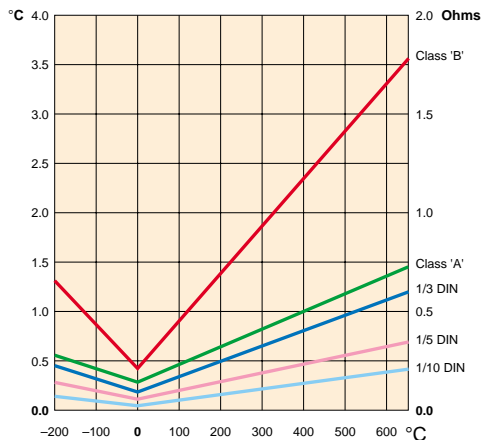

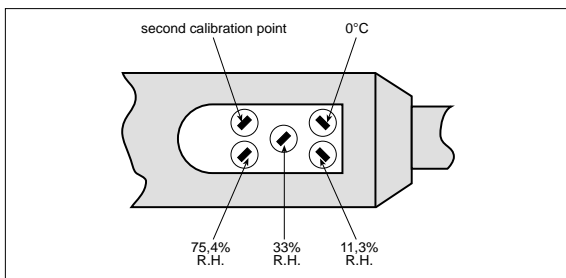

1



4



2



5



3

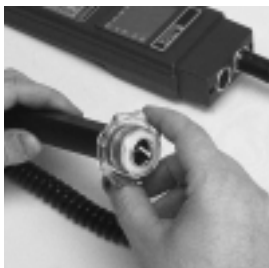

6



7



10



8



11

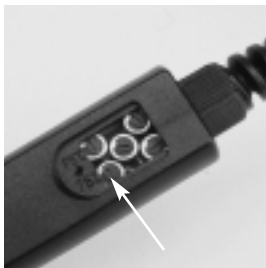

9

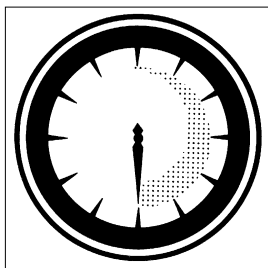

12



13



16

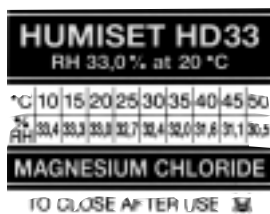

14



17



15



18



19



22



20

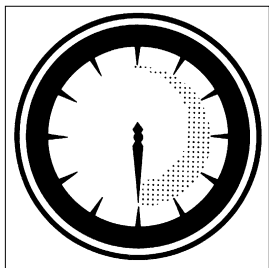

23



21

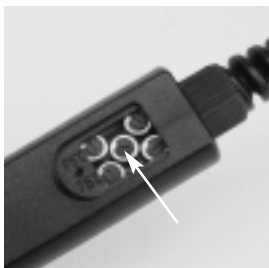

24



25



28



26



29



27



30

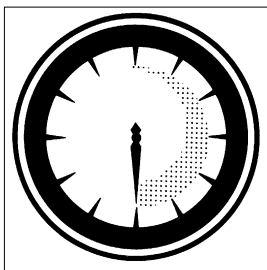

31

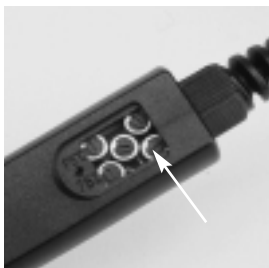

34



32



35



33



36



37



38



B) Instructions for calibration of the TEMPERATURE section of combined Relative Humidity / Temperature probes in the series HD 8501S...

Foreword:

Save in cases where the thin film platinum probe Pt100 (100 Ω at 0°C) is working in a particularly hostile or corrosive environment, or if the calibration trimmers have been tampered with, the temperature probe rarely loses calibration, so we advise you not to take any action unless you are sure what you are doing.

The calibration sequence is performed in the following order:

- | | |
|-----------------------------|-------|
| 1 st calibration | 0°C |
| 2 nd calibration | 100°C |

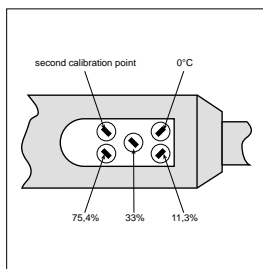

The first calibration point is always 0°C.

For correct calibration it is very important for the environment temperature to be stable and for both the probe and the simulator to be at the same temperature. We recommend 20°C.

Calibration sequence:

1. Unscrew the probe protection filter with the instrument switched off. Be very careful.
2. Carefully unsolder the temperature sensor.
3. In its place connect a precision Pt100 simulator.
4. At the probe input, simulate 0.0°C, corresponding to 100.00 Ω .
5. Open the door of the compartment housing the calibration trimmers using a suitably sized cross-head screwdriver.
6. The probe is connected to the instrument. Switch on the instrument. Ensure that the measurement is stable.
7. Using a small screwdriver, set the calibration trimmer for the value of 0°C. **The trimmer can rotate through 270°. Do not try to force the stop, as this would break the slot for the screwdriver.** Turn the trimmer until the value indicated on the display of the instrument corresponds to 0.0°C.

8. At the probe input, simulate 100°C, corresponding to 138.5 Ω.
9. Using a small screwdriver, turn the calibration trimmer for the value of 100°C until the value indicated by the instrument corresponds to 100.0°C. **The trimmer can rotate through 270°. Do not try to force the stop, as this would break the slot for the screwdriver.**
10. Switch off the instrument, disconnect the Pt100 simulator and very carefully resolder the Pt100 sensor. **The Pt100 sensor used has a precision rating A according to IEC 751.**
11. Turn the temperature sensor at an angle of 90° towards the extreme edge of the probe so that the sensor body protrudes from the edge.
12. Switch on the instrument. Immerse the temperature sensor in a container full up to the brim with bidistilled water at about 20°C. The container is placed over a working agitator; a reference precision thermometer will be immersed in the container.
13. Wait a few minutes until the reading is stable, then read the value on the instrument. If the value does not coincide with the reference thermometer, turn the 0°C trimmer.
14. Switch off the instrument, dry the temperature sensor with soft absorbent paper and return it to its working position.
15. Screw on the protection filter and close the door of the calibration trimmer compartment. This operation concludes calibration of the temperature section.

TECHNICAL CHARACTERISTICS

- Relative humidity sensor: capacitive.
- Temperature sensor: thin film Platinum Pt100 (100 Ω at 0°C).
- Display: dual LCD with 3½ digits, height 12.5 mm, with symbols.
- Inputs: 2.
Input A for combined relative humidity and temperature probes, series HD 8501S, HD 8501SAT/500 and HD 8501SS/500.
Input B for temperature probes, series TP 870, TP 870/A, TP 870/C, TP 870/P (Pt100 sensor with amplification and linearization circuit)
- Instrument measuring range in % R.H. with combined probes HD 8501S, HD 8501SS/500: 5...98% R.H. in the temperature range -20...+80°C. This temperature refers to the maximum temperature at which the sensor can work.
- Instrument and combined probe precision: ±2.5% R.H. in the range 5...90% R.H. ±1 digit;
+4...-2.5% R.H. ±1 digit in the range 90...98% R.H.
- Instrument measuring range in % R.H. with combined probes HD 8501SAT/500: 5...98% R.H. in the temperature range -30...+130°C. This temperature refers to the maximum temperature at which the sensor can work.
- Instrument and combined probe precision: ±2.5% R.H. in the range 5...90% R.H. ±1 digit;
+4...-2.5% R.H. ±1 digit in the range 90...98% R.H.

NOTE: Precision refers to measurements with a duration of less than 15 minutes. If the hygrometric sensor is exposed to humidity levels close to saturation for periods of more than 30 minutes the instrument may measure an excess deviation of up to +6% R.H.; when the R.H. levels fall below 90% again, the sensor returns to its original characteristics.

- Instrument measuring range in temperature: -200...600°C.
- Instrument precision in temperature measurements: $\pm 0.2^{\circ}\text{C} \pm 0.08^{\circ}\text{C}/^{\circ}\text{C}$ (linearization error) ± 1 digit.
- Typical instrument and TP 870 temperature probe precision: $\pm 0.35^{\circ}\text{C}$ in the range $-50^{\circ}\text{C}..+200^{\circ}\text{C}$ ± 1 digit, $\pm 0.6^{\circ}\text{C}$ in the remaining range ± 1 digit.
- Resolution: in R.H. 0.1 point of relative humidity, in temperature 0.1°C in the range $\pm 199.9^{\circ}\text{C}$; beyond that, 1°C .
- Response time: combined temperature and R.H. probe at constant temperature, excursion 45% R.H. \rightarrow 90% R.H., without protection at 63% of the final value: 2 seconds; at 90% of the final value: 10 seconds.

NOTE: The response time refers to a measurement taken in air at a constant temperature. For correct measurement the temperature of the R.H. sensor must be the same as that of the air of which you want to measure the humidity. Differences in temperature between the sensor and the air cause errors in measurement because the temperature influences the relative humidity of the air. Higher (or lower) temperatures of the probe container radiate or absorb heat to or from the sensor. The response time of the temperature probes depends on the model chosen, whether for immersion, contact, air or penetration.

- Absolute humidity: absolute humidity is calculated by taking as reference the relative humidity at the time and the temperature conditions with reference to the volume of a humid gas at a temperature $T = 0^{\circ}\text{C}$ and pressure $P = 1013$ mbar. Measuring range: $0...3500$ g/m³.
- Dew point: the dew point measurement falls within the range of temperature measurement of the R.H. probes. The dew point of a gas is the temperature at which the humidity in the gas starts to condense.

t: $-50^{\circ}\text{C}..+200^{\circ}\text{C}$ resolution 1°C
 $-58^{\circ}\text{F}..+392^{\circ}\text{F}$ resolution 1°F

- Instrument conversion frequency: 2 per second.
- Instrument working temperature: $-5^{\circ}\text{C}..50^{\circ}\text{C}$, $0...90\%$ R.H. excluding condensate.
- Working temperature of the electronics which is contained in the handle of the HD 8501S... series of probes: $-5...+50^{\circ}\text{C}$.
- Storage temperature: $-20^{\circ}\text{C}..+60^{\circ}\text{C}$.
- Power supply: 9V battery, IEC 6LF22; work time with alkaline battery 100 hours.
- Connectors: input A, DIN 41524 female five-pole circular connector for probes in series HD 8501S...; input B, DIN 41524 female eight-pole circular connector for probes in series TP 870; serial output male 9-pole SUB-D connector.
- Instrument case: ABS.
- Dimensions of instrument alone: 72 x 40 mm.
Kit: 370 x 295 x 85 mm.
- Instrument weight: 350 gr.
Kit 1600 gr.

ORDER CODE

DO 9406K : Diplomatic carrying case instrument DO 9406, probe HD 8501S, CP 232 C.

OPTIONAL

- HD 8501S** : Combined temperature and relative humidity probe. Humidity sensor working temperature range: -10...+70°C.
- P1** : Stainless steel mesh protection for the standard probe HD 8501S.
- P2** : 20 µ sintered PE protection for the probe HD 8501S.
- P3** : Protective cap for the probe HD 8501S completely made of 20 µ sintered bronze.
- P4** : Protective cap for the probe HD 8501S completely made of 20 µ sintered PE.
- HD 8510SAT/500** : Combined humidity and temperature probe. Working temperature range -30...+130°C, diam. 12 x 580 mm.
- HD 8501SS/500** : Combined sword probe for humidity and temperature. Humidity sensor working temperature range -10...+70°C, \varnothing 18x4 L=530 mm.
- TP 870** : Immersion temperature probe, diam. 3 x 230 mm, measuring range -60...+400°C.
- TP 870P** : Penetration temperature probe, diam. 4 x 150 mm, measuring range -60...+400°C.
- TP 870C** : Contact temperature probe, diam. 5 x 230 mm, measuring range -60...+400°C.
- TP 870A** : Air temperature probe, diam. 4 x 230 mm, measuring range -60...+300°C.
- CP 232 C** : Connecting cable from SUB D female 9-pole to SUB D female 25-pole, for serial output RS232C.







Relative humidity saturated solutions for calibrating the % R.H. probes

HD 11 corresponding to 11.3% R.H. at 20°C.

HD 33 corresponding to 33.0% R.H. at 20°C.

HD 75 corresponding to 75.4% R.H. at 20°C.

EXAMPLES OF USE OF THE KEYBOARD

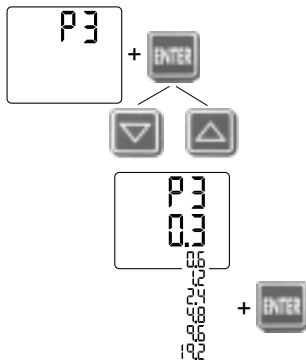

1.  Switches the instrument on or off.
2.  Blocks or releases updating of the display.
3.  The temperature reading may be in °C or °F.
4.  The instrument measures the relative humidity.
5.  The measurement may be chosen in D.P., dew point, or g/m³, grams of water per cubic metre of air.
6.  Before pressing the key the baud rate must be set, which has to be compatible with the printer or computer to which the instrument is to be connected.

A) Setting the BAUD RATE:

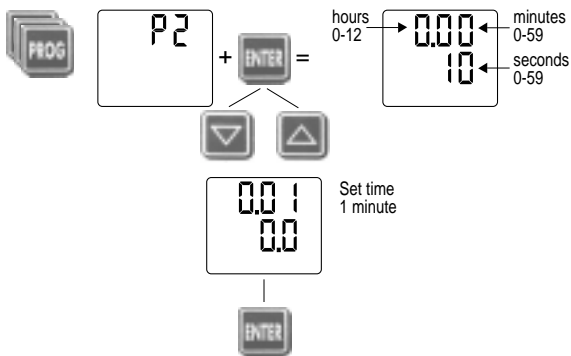

B) Setting the reading or storage interval.



At this point the  key may be pressed. The  key flashes. To quit, press . It will take a few seconds for the Serial Out/Memory key to stop flashing because, after the last value has been printed, the MAX, MIN and MED values are printed too.

7.  When the key is pressed the instrument starts to store and update the current MAX, MIN, and MED value.

RCD

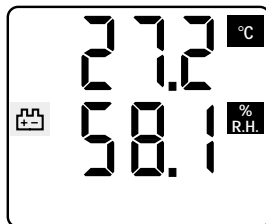

beep

When it is pressed for a few seconds it emits a beep, clears the Maximum, Minimum and Mean value and starts again, to update the MAX, MIN, MED values.



RCD

8. Pressing DATA CALL gives:



The Maximum value of the probe connected to input A



The Minimum value of the probe connected to input A



The Mean value of the probe connected to input A





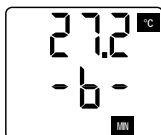

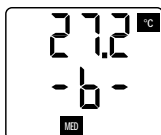

The Maximum value of the probe connected to input B



The Minimum value of the probe connected to input B

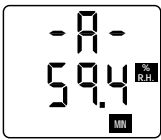

The Mean value of the probe connected to input B

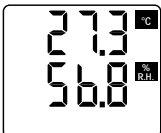
7.   Depending on the parameter chosen - % R.H., D.P. or g/m^3 - the display shows the Maximum value of the probe connected to input A
8.   the Minimum value
9.   the Mean value
10.   the current value

9.  When the key is pressed the instrument starts or stops storage. The Serial Out/Memory symbol appears or disappears.

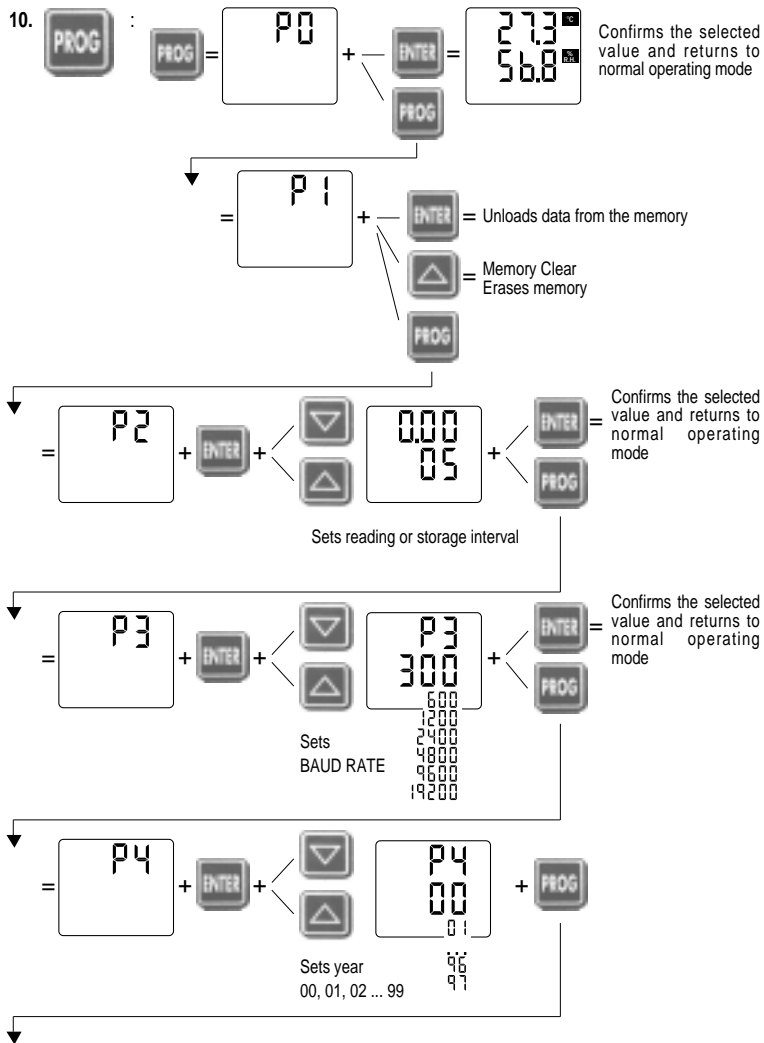

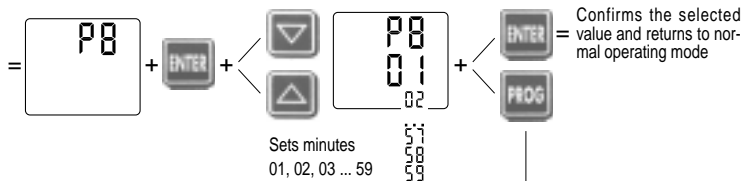
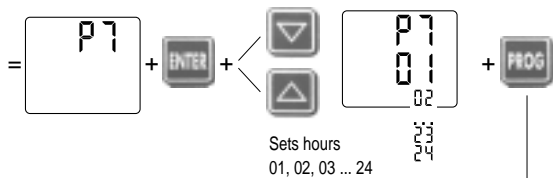
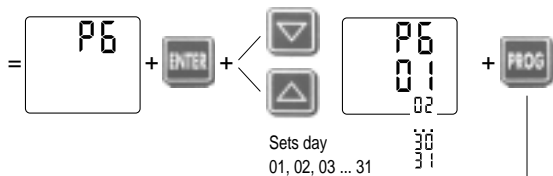
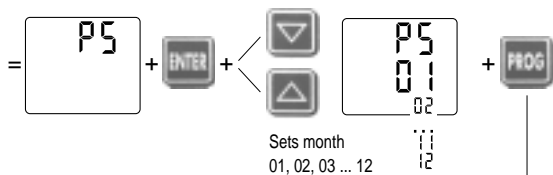

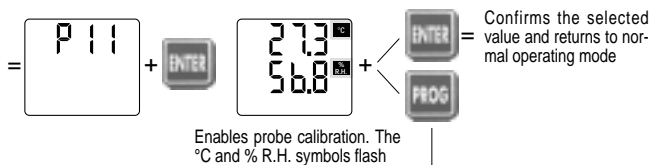
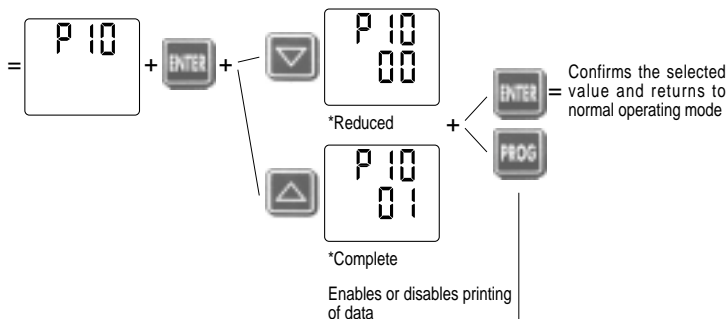
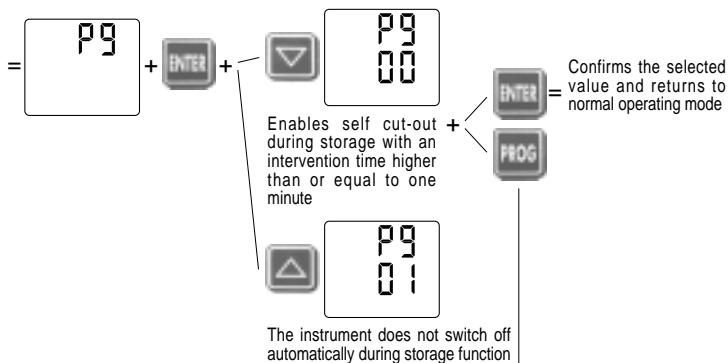

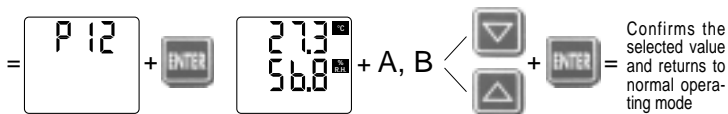

Enables instrument calibration as specified in the manual on pages:

A = page 85

B = page 97



DELTA OHM SRL
VIA G. MARCONI, 5 - 35030 CASELLE DI SELVAZZANO (PD) - ITALY
TEL. 0039-0498977150 r.a. - FAX 0039-049635596
e-mail: deltaohm@tin.it - Web Site: www.deltaohm.com