

Engineer	L. Castellani	<b>INFN sez. PADOVA</b> TITLE: DT_C0B5 Size A3
Drawn by	L. Castellani	
R&D CHK		
DOC CTRL CHK		
MFG ENGR CHK		

REV	5.0	REV	5.0
Drawing Number		Sheet 1	of 9

1	2	3	4	5	6	7	8		
Changed by	castellani	Date	Changed	Wednesday,	July 23,	2003	Time	Changed	0A:10

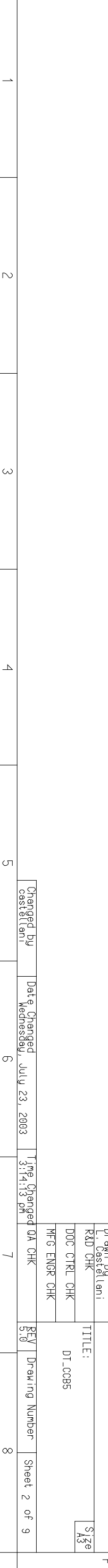
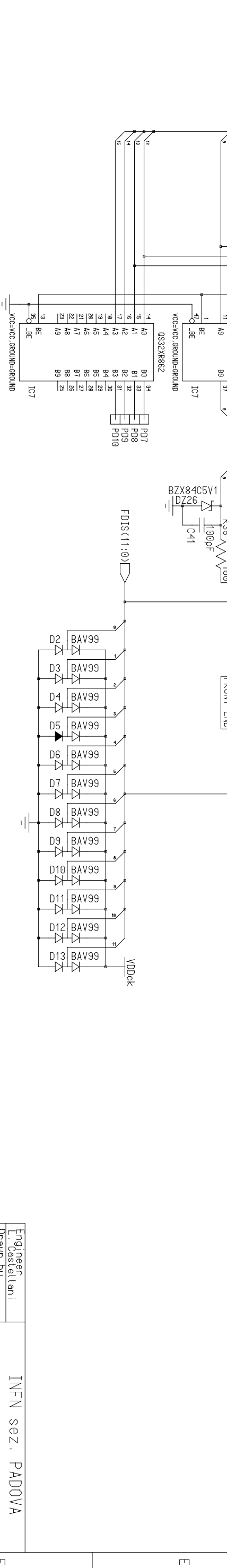
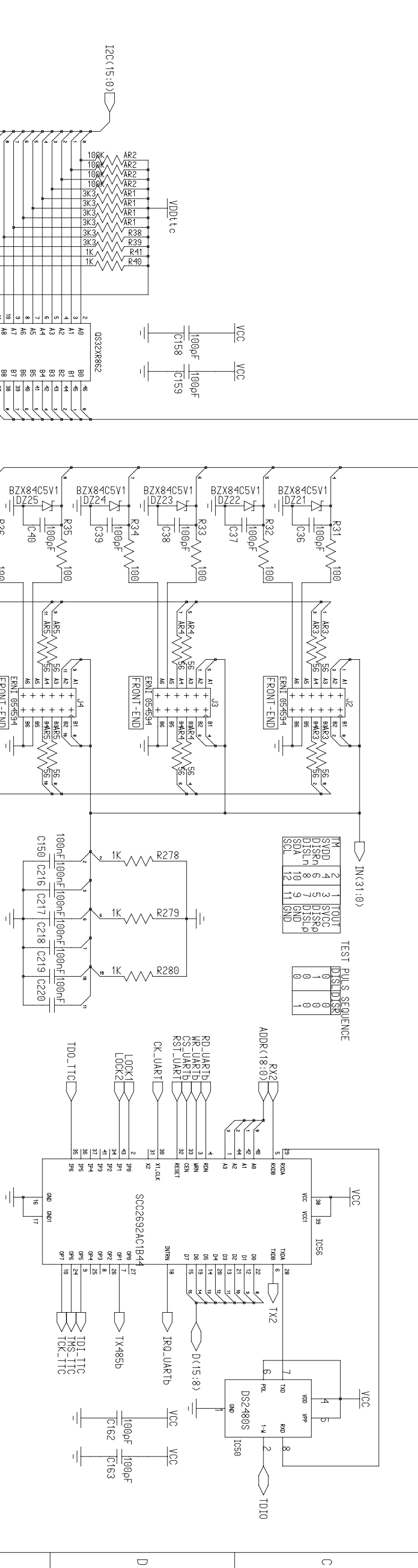
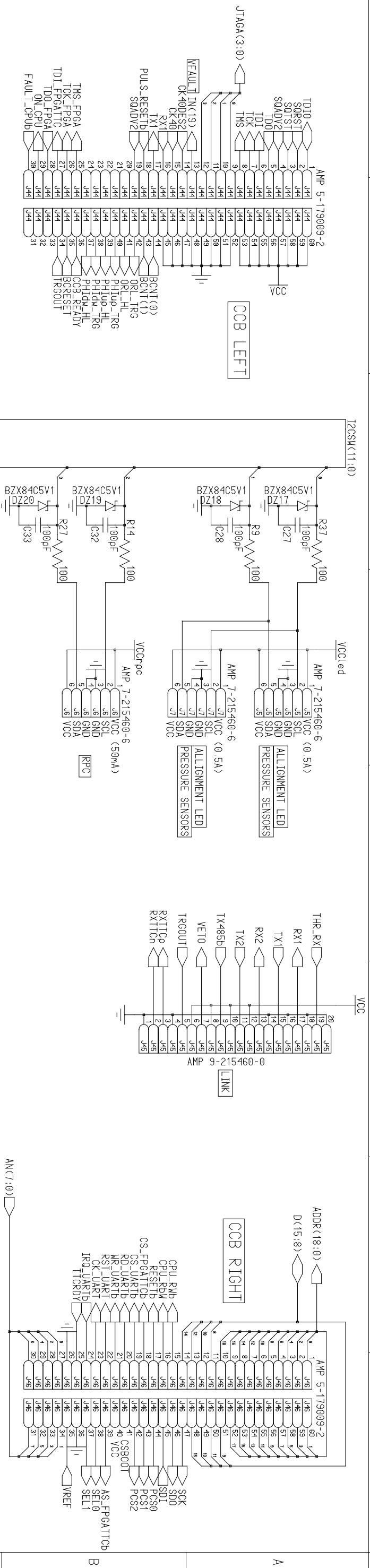

Changed by  Date:  Wednesday, July 23, 2003  
 Time:  3:14:13 pm

Engineer	L. Castellani	TITLE:	INFN sez. PADOVA
Drawn by	L. Castellani	DT_CCB5	
DOC_CTRL_CHK			
WFG_ENGR_CHK			
REV	5.0	REV	5.0
Drawing Number		Sheet	2 of 9

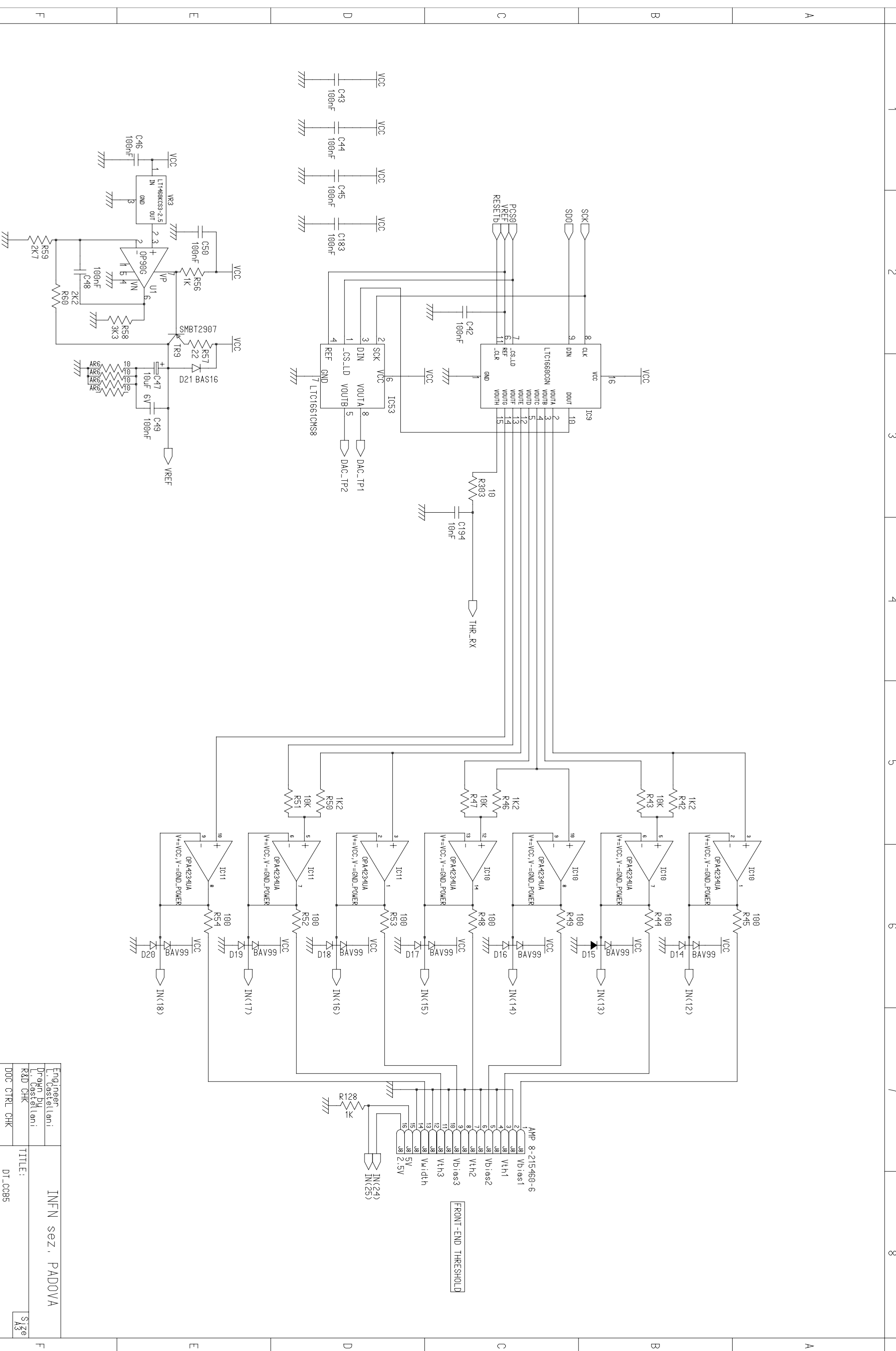

Changed by	Date	Time
castellani	Wednesday, July 23, 2003	4:02:47 pm
Changed by	Date	Time
castellani	Wednesday, July 23, 2003	4:02:47 pm

Engineer	L. Castellani
Drawn by	L. Castellani
R&D CHK	
DOC CTRL CHK	
MFG ENGR CHK	
TITLE:	DT_C085
REV	5.0
Drawing Number	
Sheet 3	of 9

INFN sez. PADOVA

Size A3

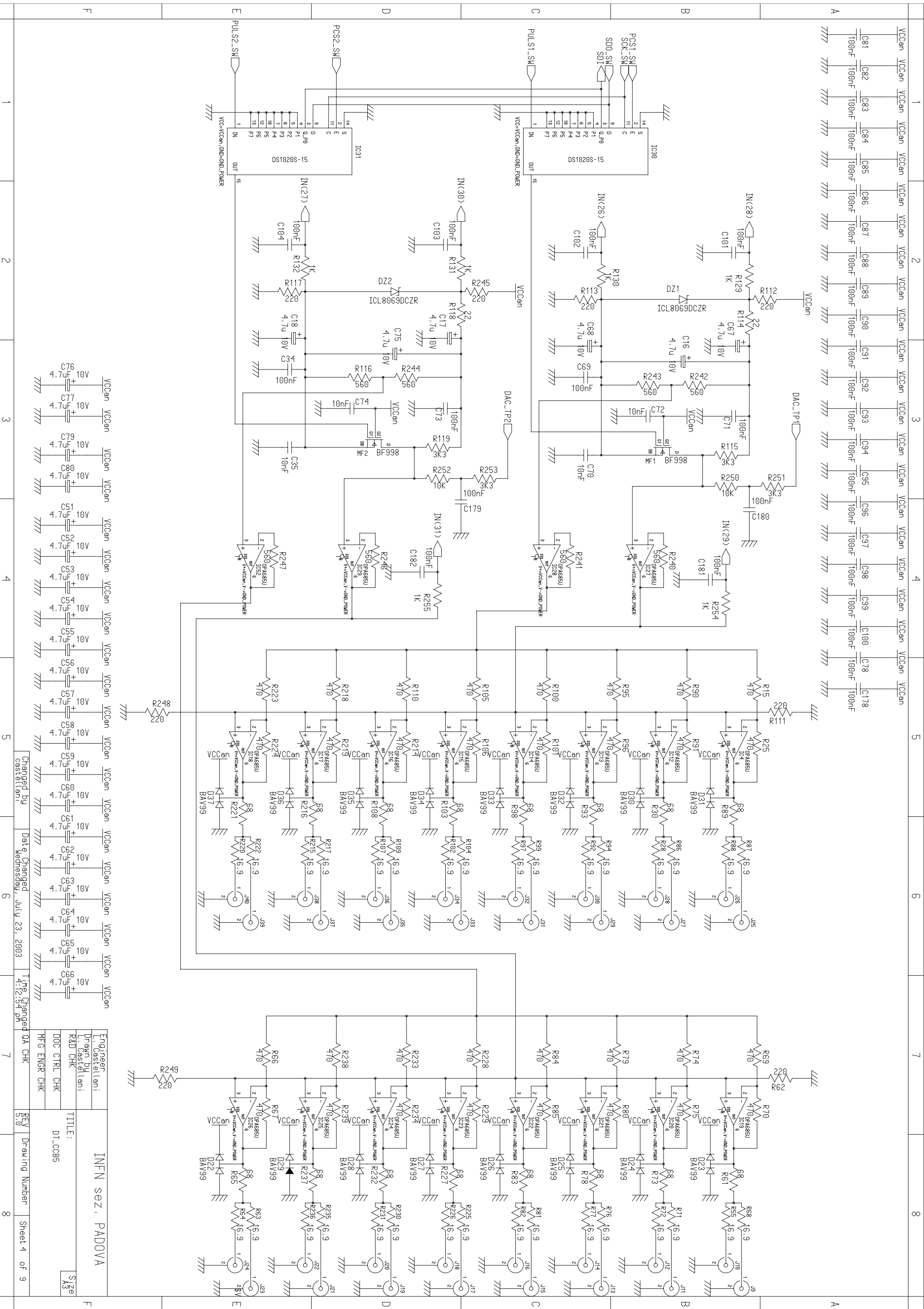

Eng'ner  
 L. Castellani  
 Drawn by  
 L. Castellani  
 R&D CHK  
 DOC CTRL CHK  
 MFG ENGR CHK

**INFN sez. PADOVA**  
 TITLE:  
 DI\_COB5

Size  
 A3

Date Changed  
 Wednesday, July 23, 2003  
 Time Changed  
 4:12:54 pm

Changed by  
 castellani  
 REV 5.0  
 Drawing Number  
 Sheet 4 of 9

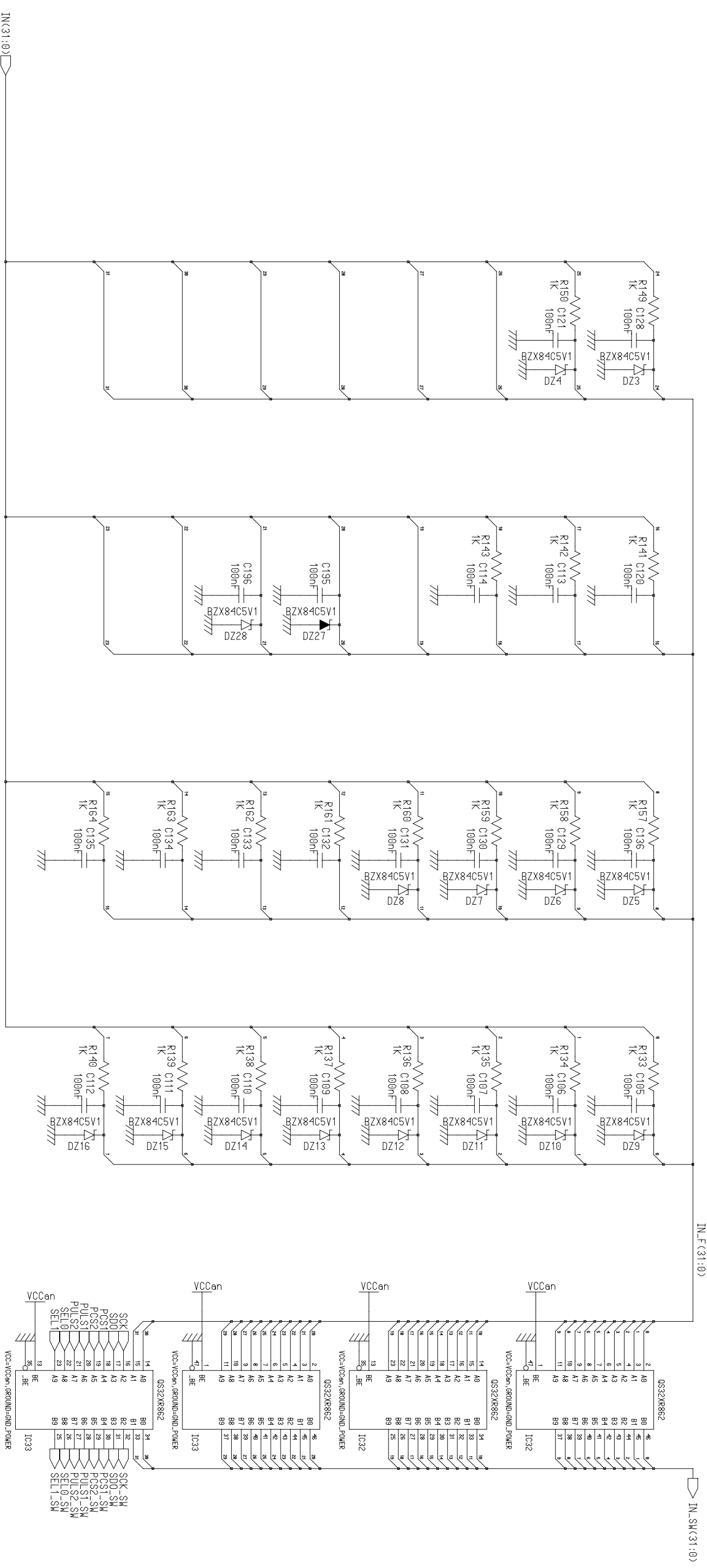
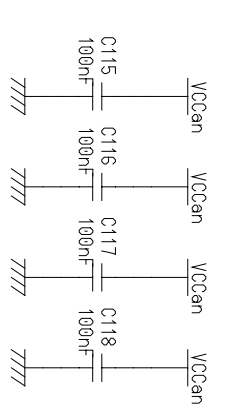

1	2	3	4	5	6	7	8
<p>Engineer: L. Castellani          Drawn by: L. Castellani          R&amp;D CHK          DOC CTRL CHK          MFG ENGR CHK</p> <p>INFN sez. PADOVA</p> <p>TITLE: DT_CCB5</p> <p>Size: A3</p>							8
<p>Changed by: castellani          Date: Wednesday, July 23, 2003 17:40:59 pm          Time: Changed QA CHK</p>							7
<p>REV: 5.0          Drawing Number: Sheet 5 of 9</p>							6
<p>Changed by: castellani          Date: Wednesday, July 23, 2003 17:40:59 pm          Time: Changed QA CHK</p>							5
<p>Changed by: castellani          Date: Wednesday, July 23, 2003 17:40:59 pm          Time: Changed QA CHK</p>							4
<p>Changed by: castellani          Date: Wednesday, July 23, 2003 17:40:59 pm          Time: Changed QA CHK</p>							3
<p>Changed by: castellani          Date: Wednesday, July 23, 2003 17:40:59 pm          Time: Changed QA CHK</p>							2
<p>Changed by: castellani          Date: Wednesday, July 23, 2003 17:40:59 pm          Time: Changed QA CHK</p>							1

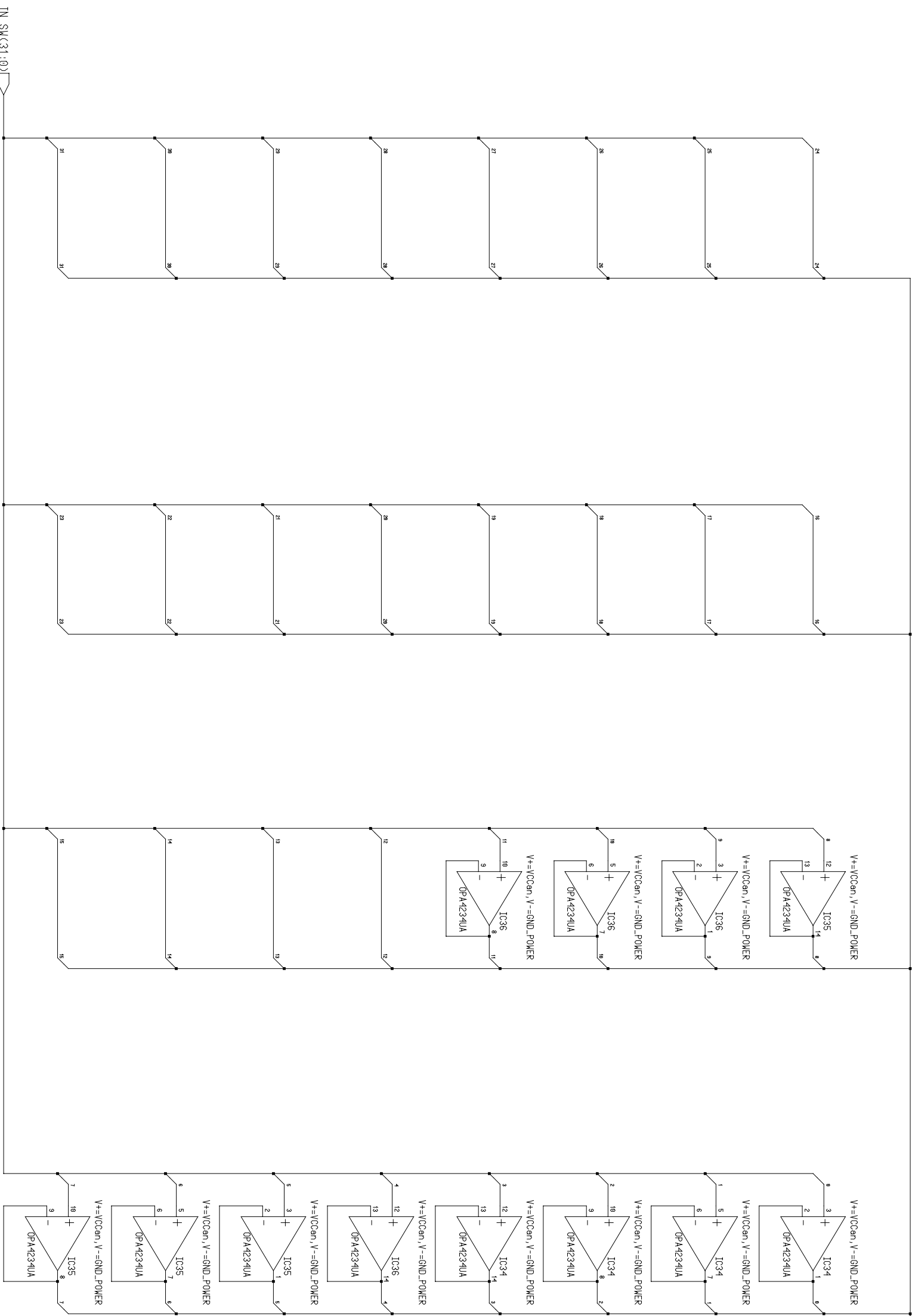
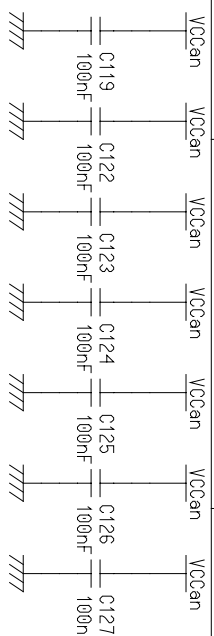
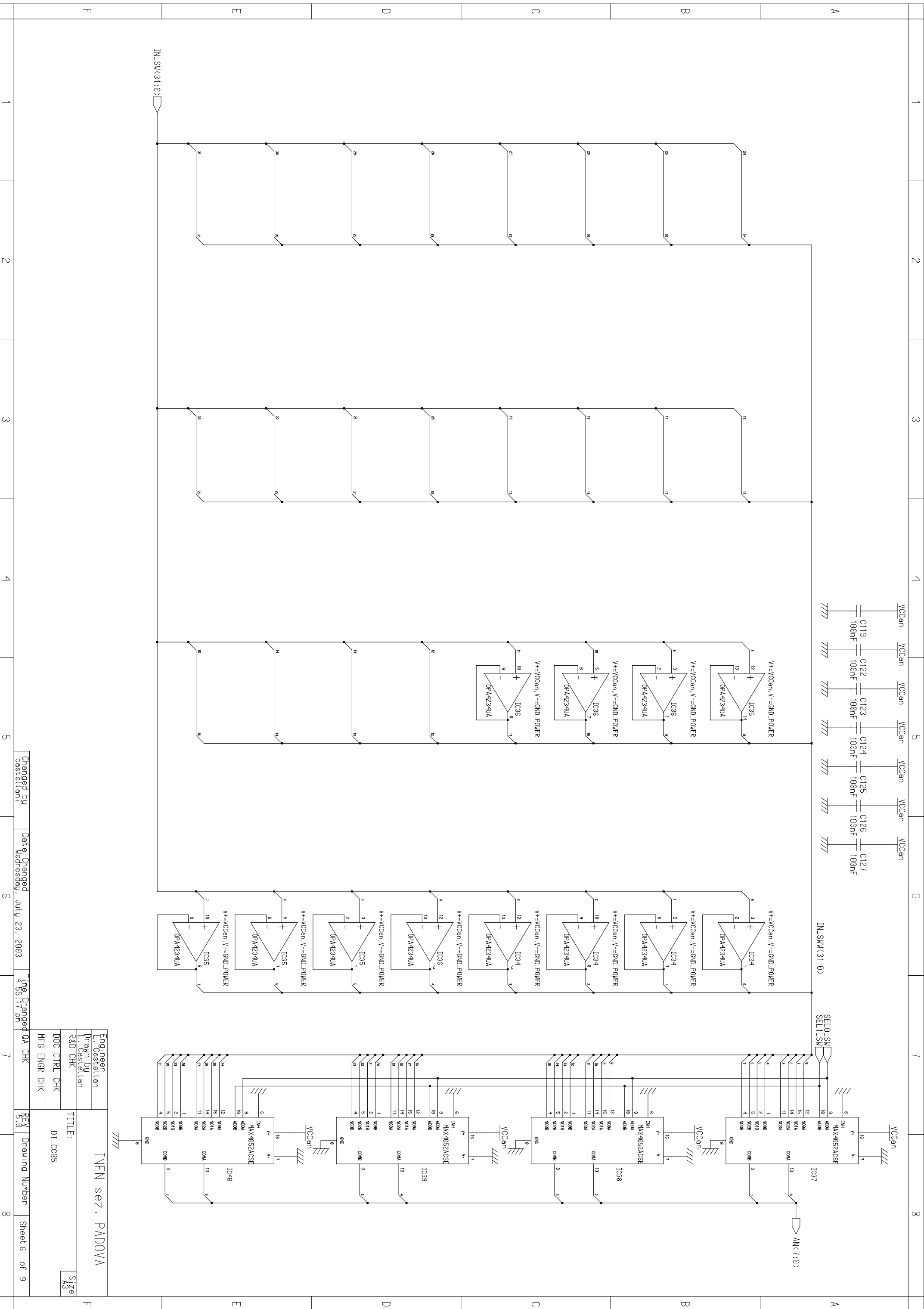

Engineer: L. Castelli

Drawn by: L. Castelli

R&D CHK: [ ]

DOC CTRL CHK: [ ]

MFG ENGR CHK: [ ]

INFN sez. PADOVA

TITLE: DT\_C085

Size A3

Changed by: castelli Date: Wednesday, July 23, 2003 Time: 4:55:17 pm

REV: 5.0 Drawing Number: Sheet 6 of 9

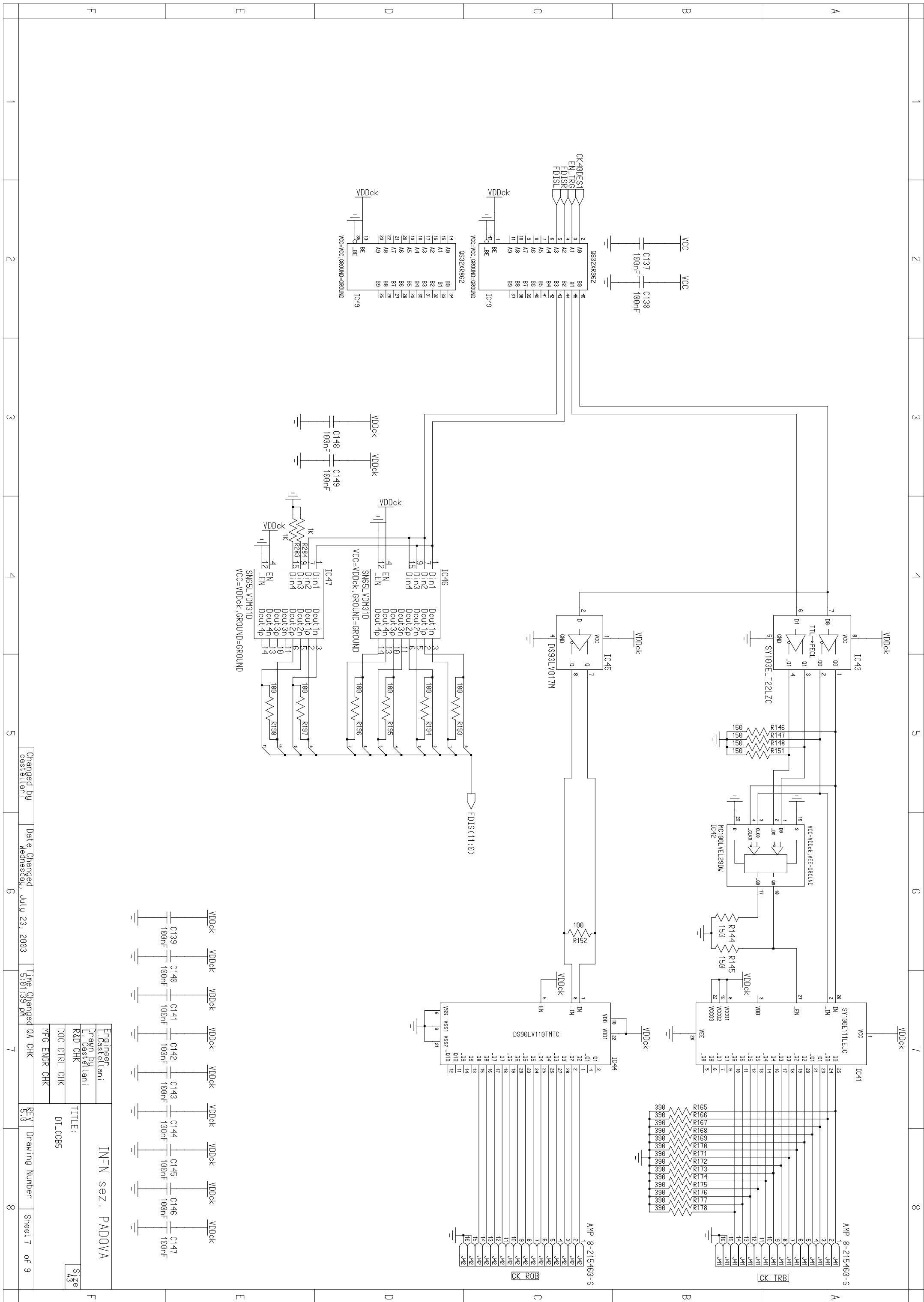

Engineer: **INFN sez. PADOVA**  
 Drawn by: **DT\_C0B5**  
 R&D CHK: **DT\_C0B5**  
 DOC CTRL CHK: **DT\_C0B5**  
 MFG ENGR CHK: **DT\_C0B5**

Changed by: **castellani** Date: **Wednesday, July 23, 2003** Time: **5:01:39 pm**  
 REV: **5.0** Drawing Number: **Sheet 7 of 9**

TITLE: **DT\_C0B5** Size: **A3**

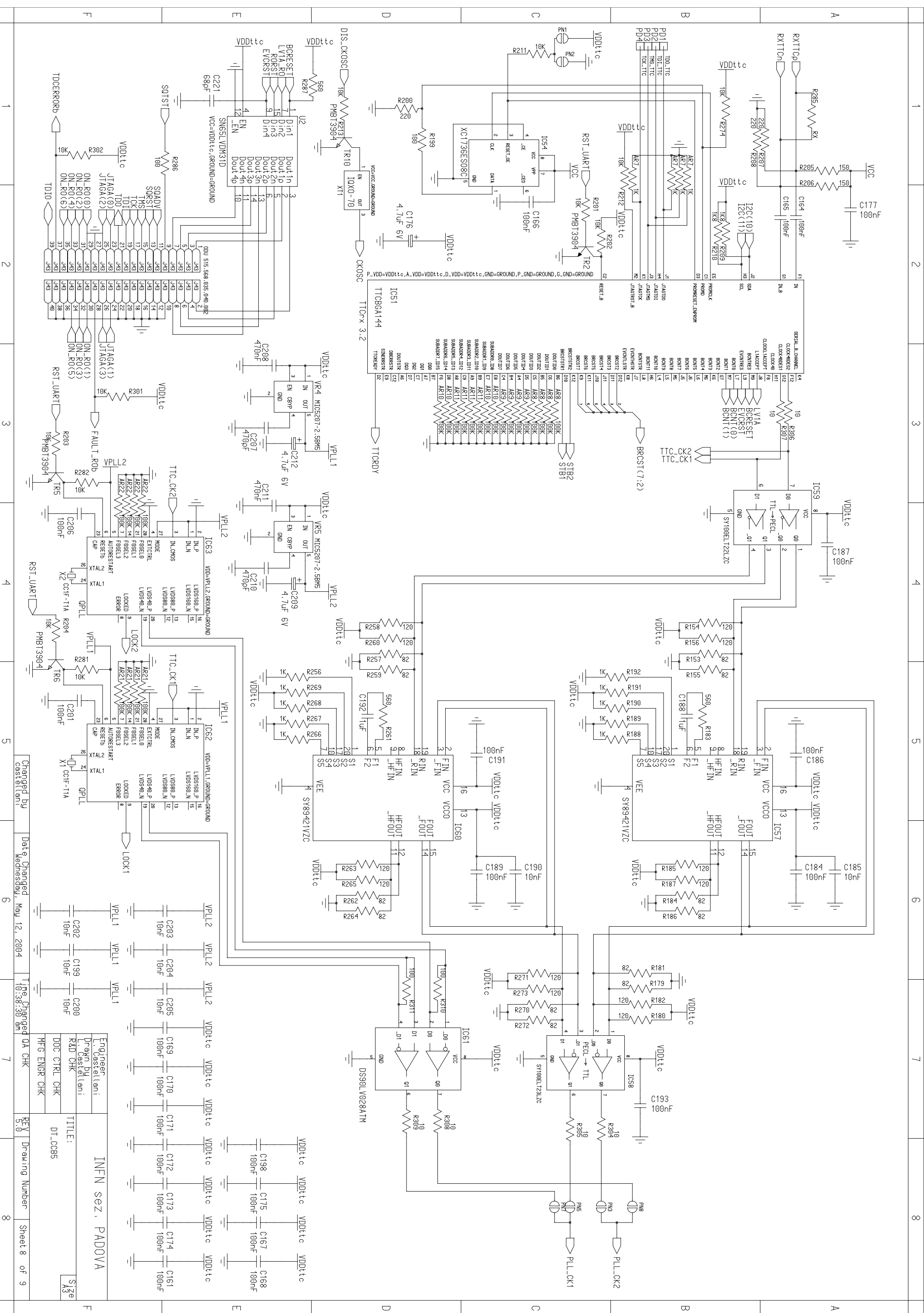

Changed by cast@lani Date: Wednesday, May 12, 2004 Time: 10:38:30 am

Engineer: L. Castellani  
Drawn by: D. Castellani  
R&D CHK: DT-CCBS  
DOC CTRL CHK: DT-CCBS  
MFG ENDR CHK: DT-CCBS

TITLE: INFN sez. PADOVA  
DT-CCBS  
REV: 5.0  
Drawing Number: Sheet 8 of 9



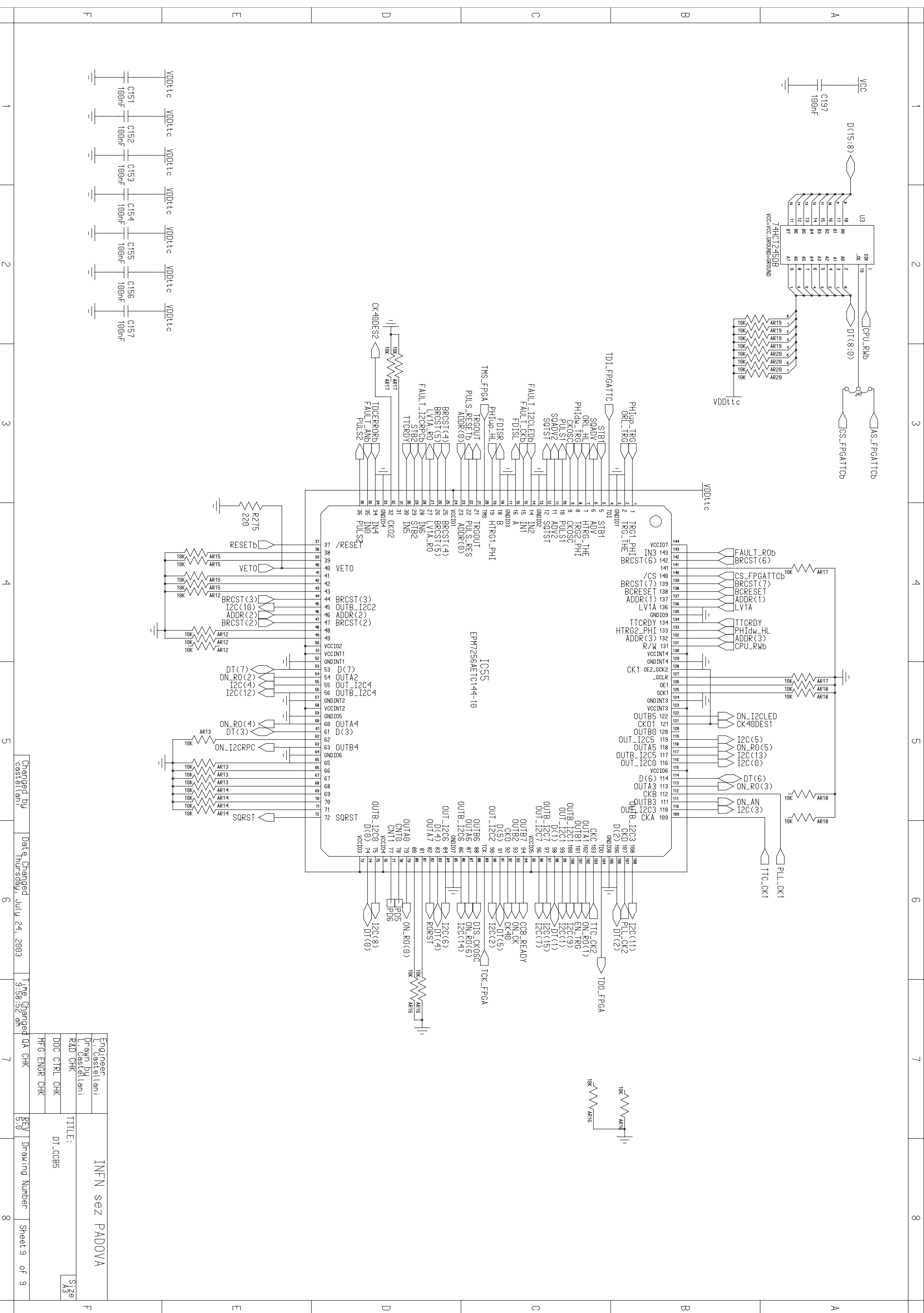

Engineer	L. Castellani
Drawn by	L. Castellani
R&D CHK	
DOC CTRL CHK	
MFG ENGR CHK	
TITLE:	DT_CCB5
REV	5.0
Drawing Number	Sheet 9 of 9

Changed by  
castellani

Date: Changed  
Thursday, July 24, 2003

Time: Changed  
9:58:52 am