

 INFN - Sezione di PADOVA Servizio Progettazione Officina Elettronica		PROJECT BY		EXPERIMENT	BOARD NAME
		L. Castellani		CMS_MU	TRB_Theta_FPGA_v3.0
DRAWN BY		DESIGN SERIAL NUMBER		REV	
Fabris/Colucci		FF12_001		1	
SHEET		PAGE TITLE		SIZE	
1 OF 7		Signal CONNECTOR		A3	
Date & Time					
19-03-2012_14:27					

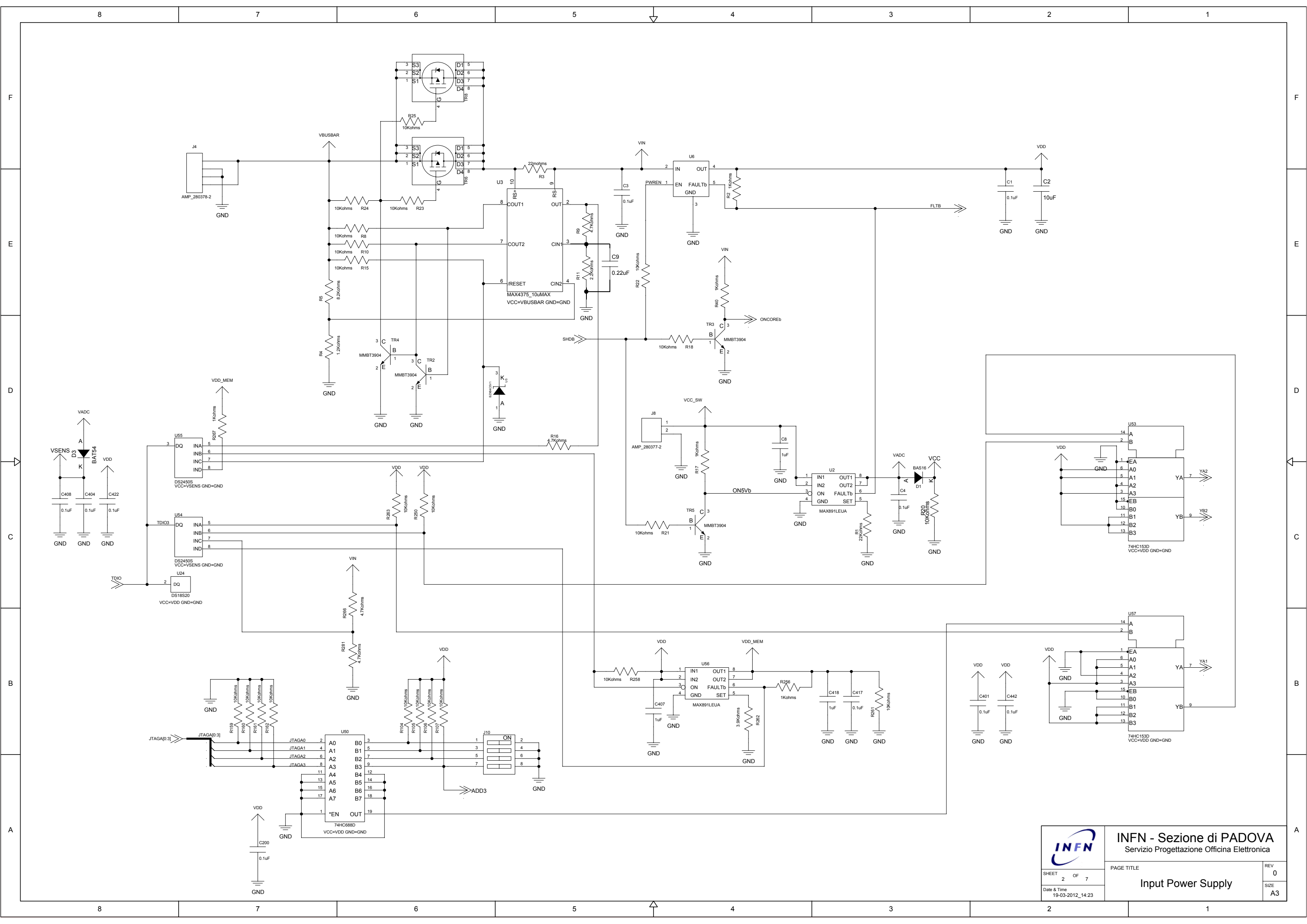

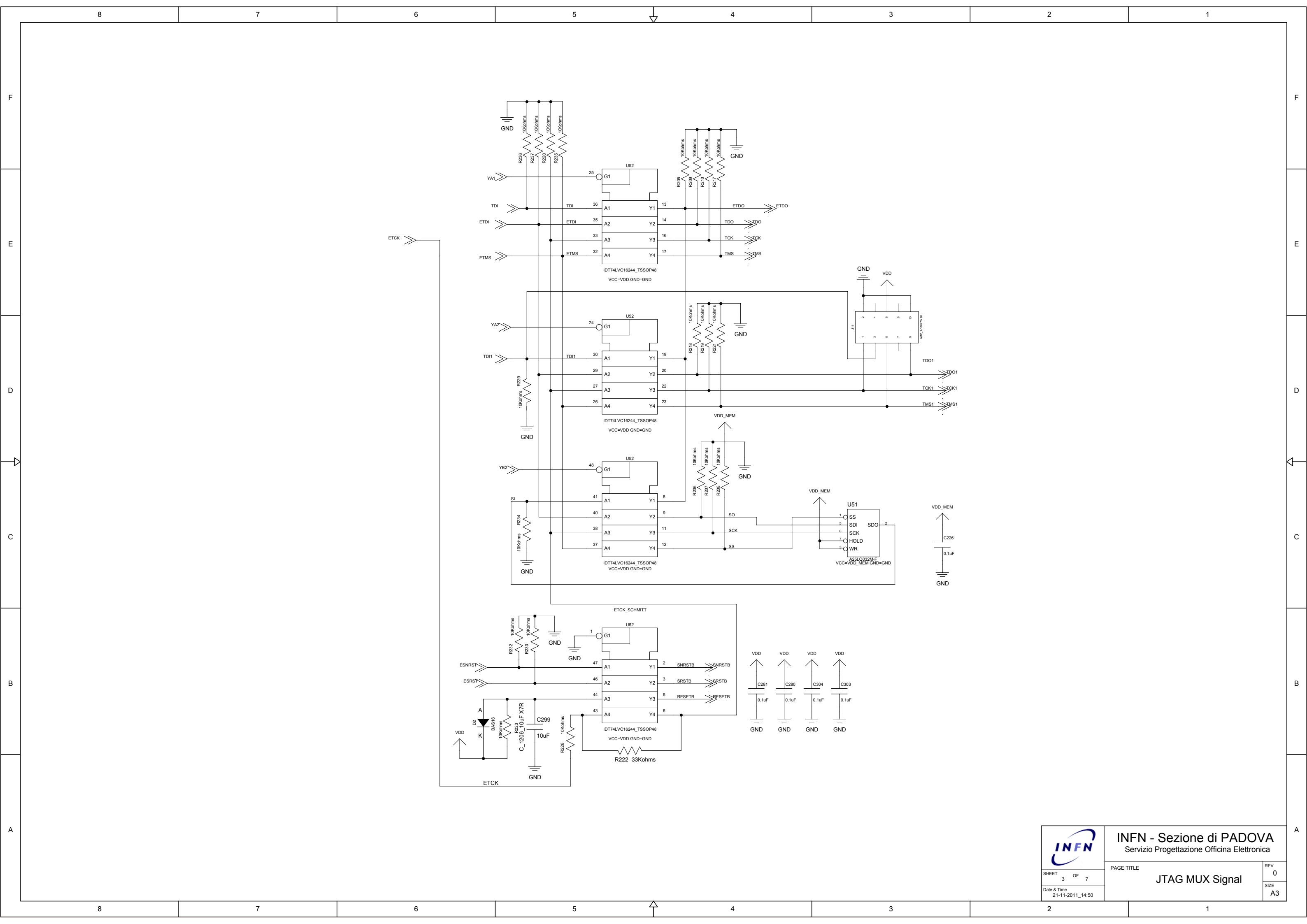

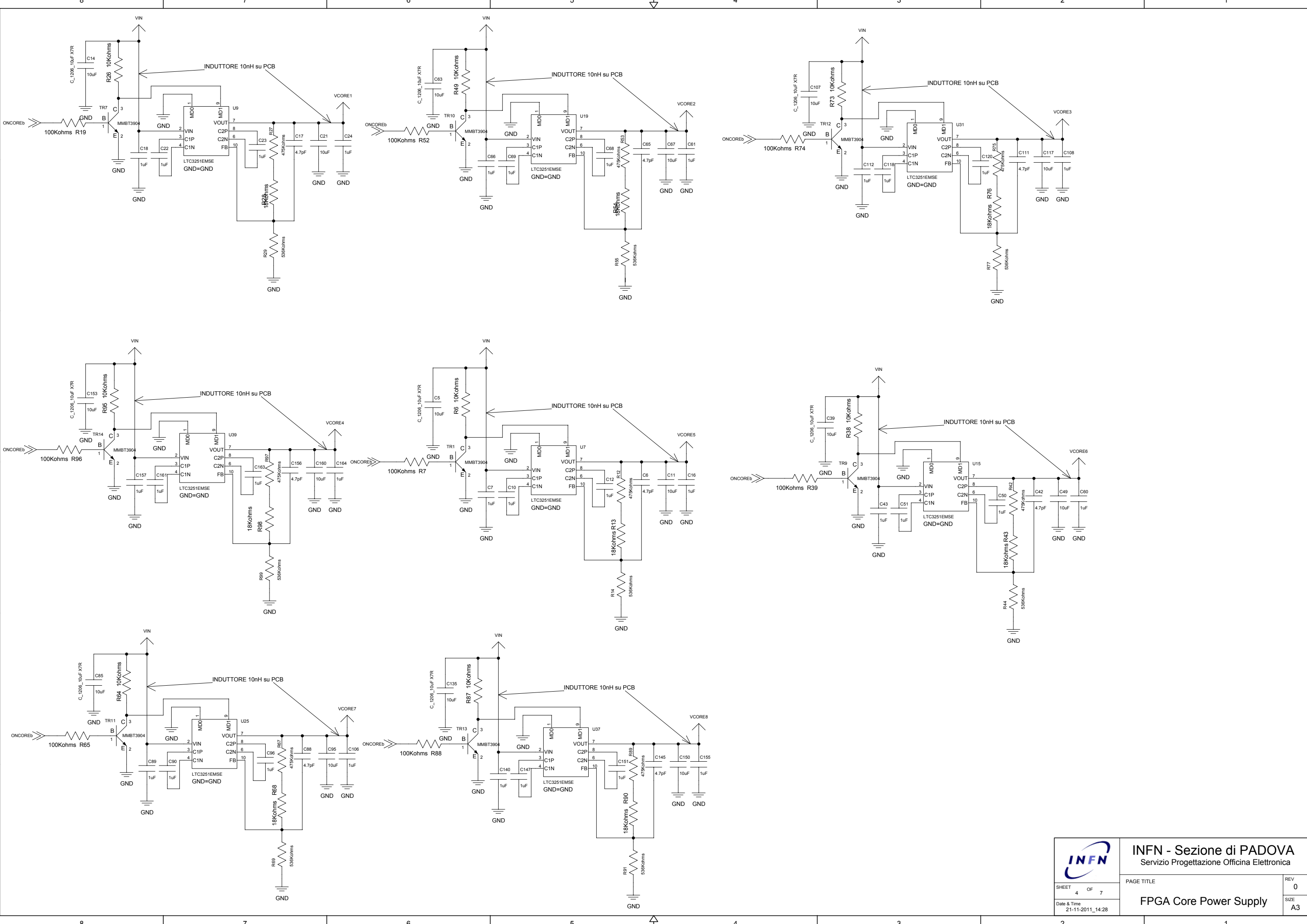

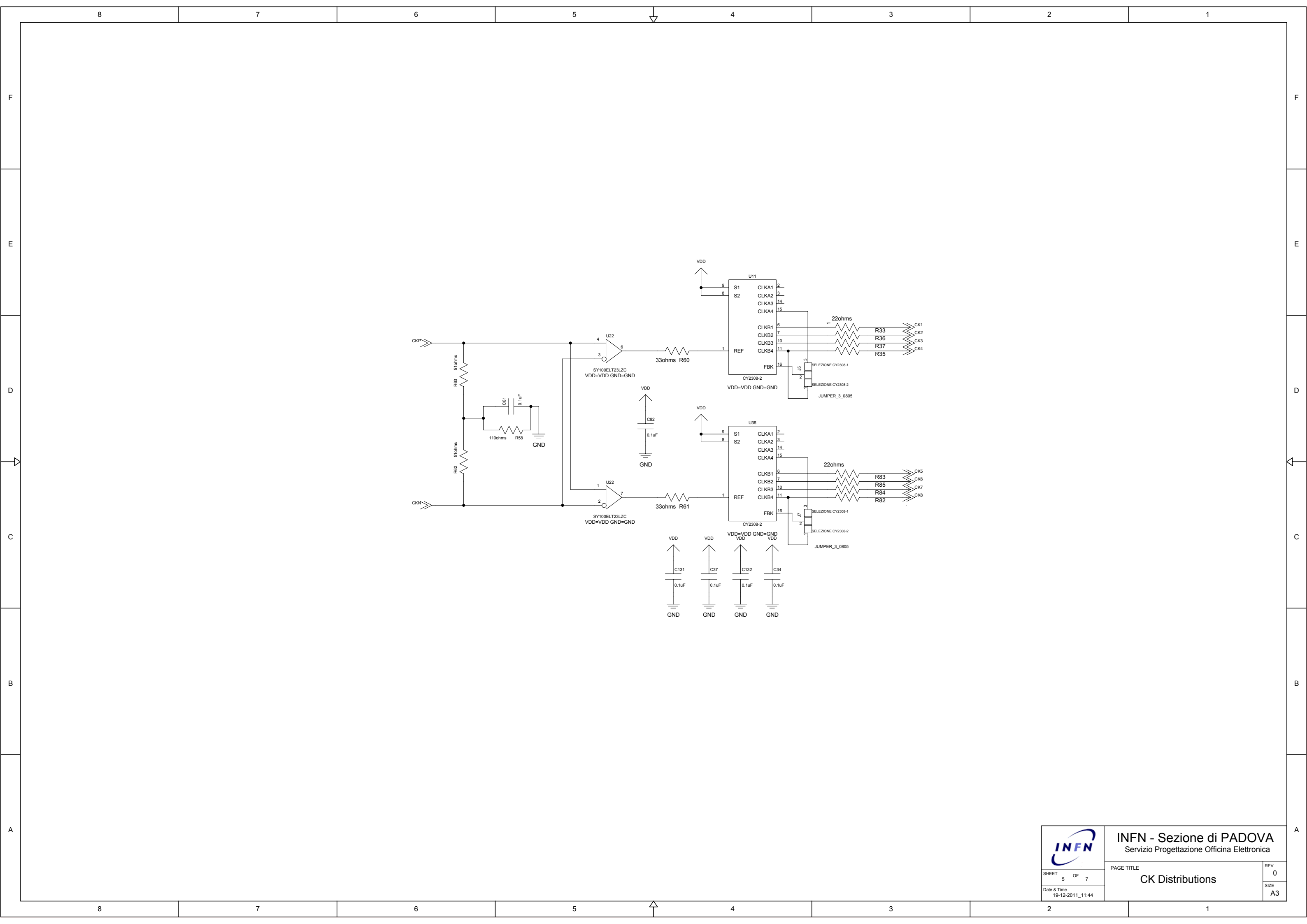

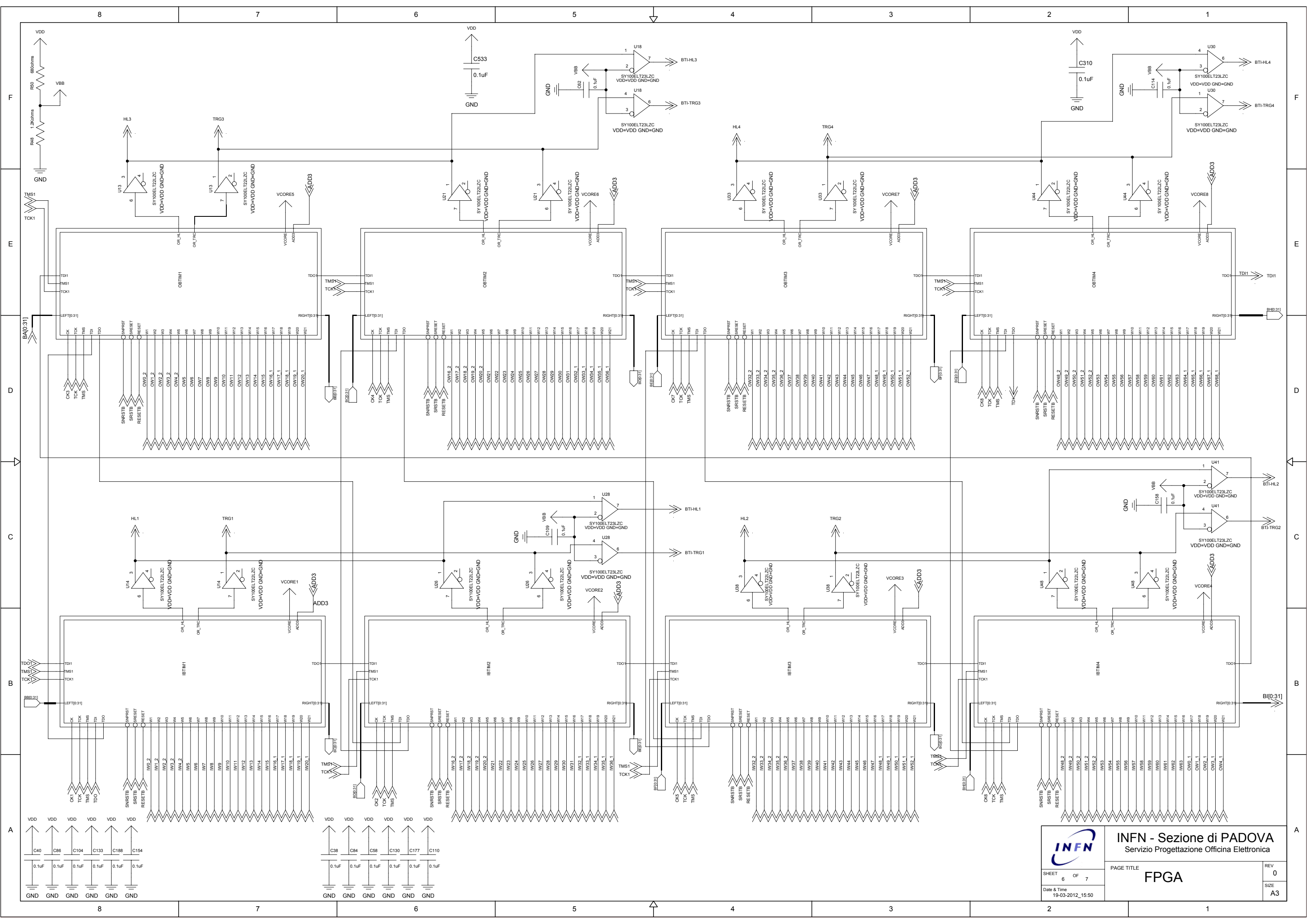

INFN - Sezione di PADOVA
 Servizio Progettazione Officina Elettronica

SHEET 6 OF 7
 Date & Time 19-03-2012_15:50

PAGE TITLE
FPGA
 REV 0
 SIZE A3

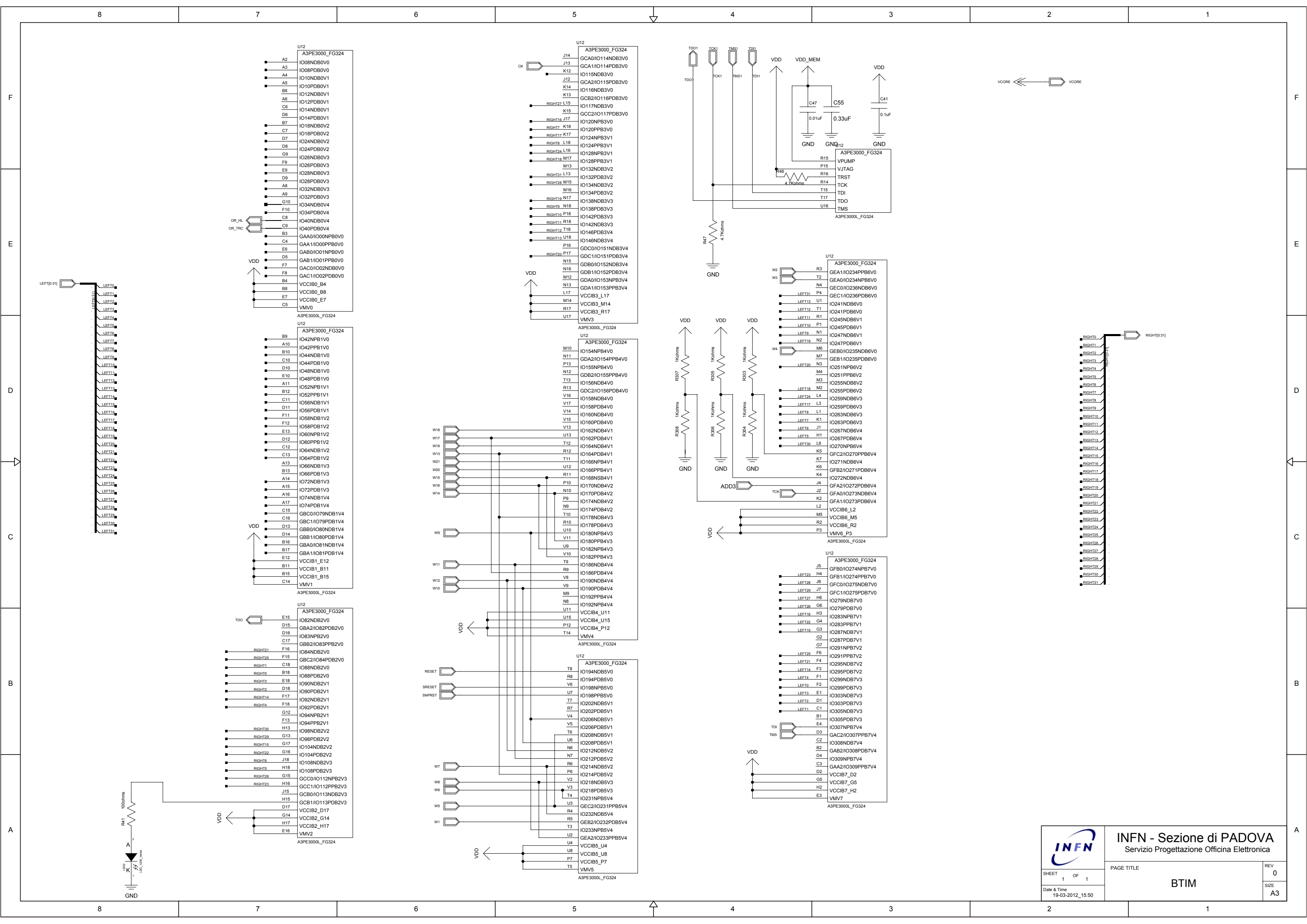

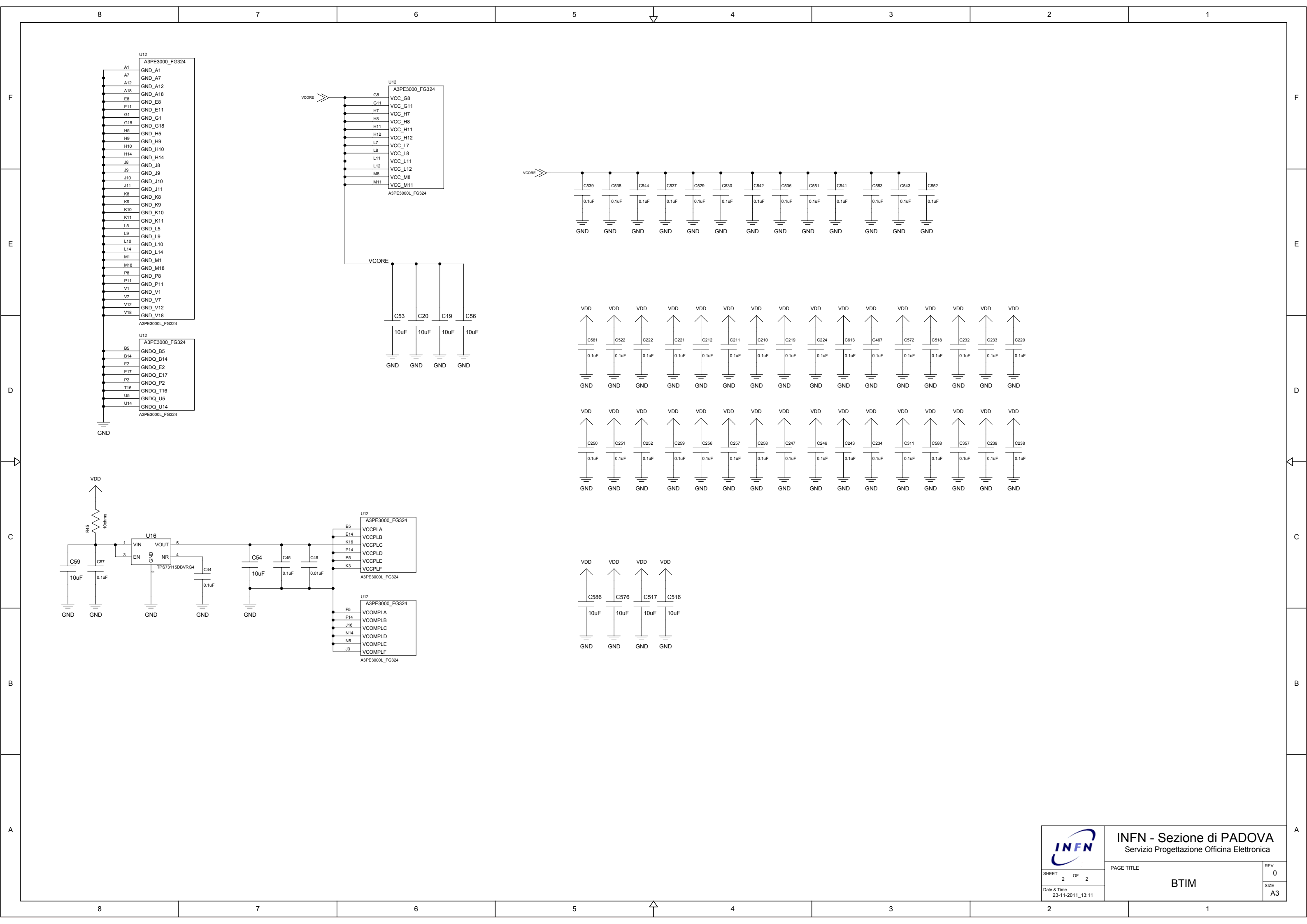

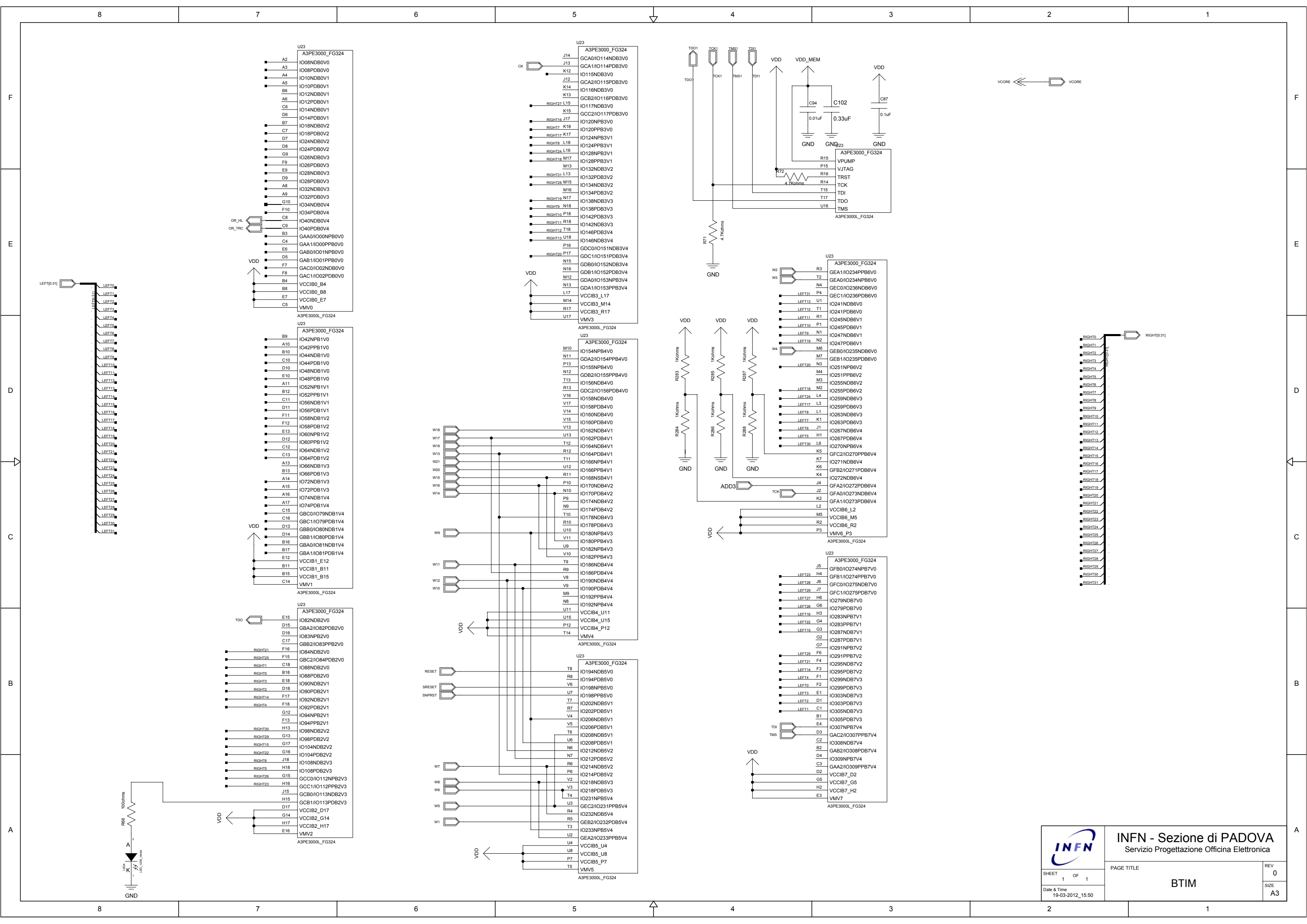

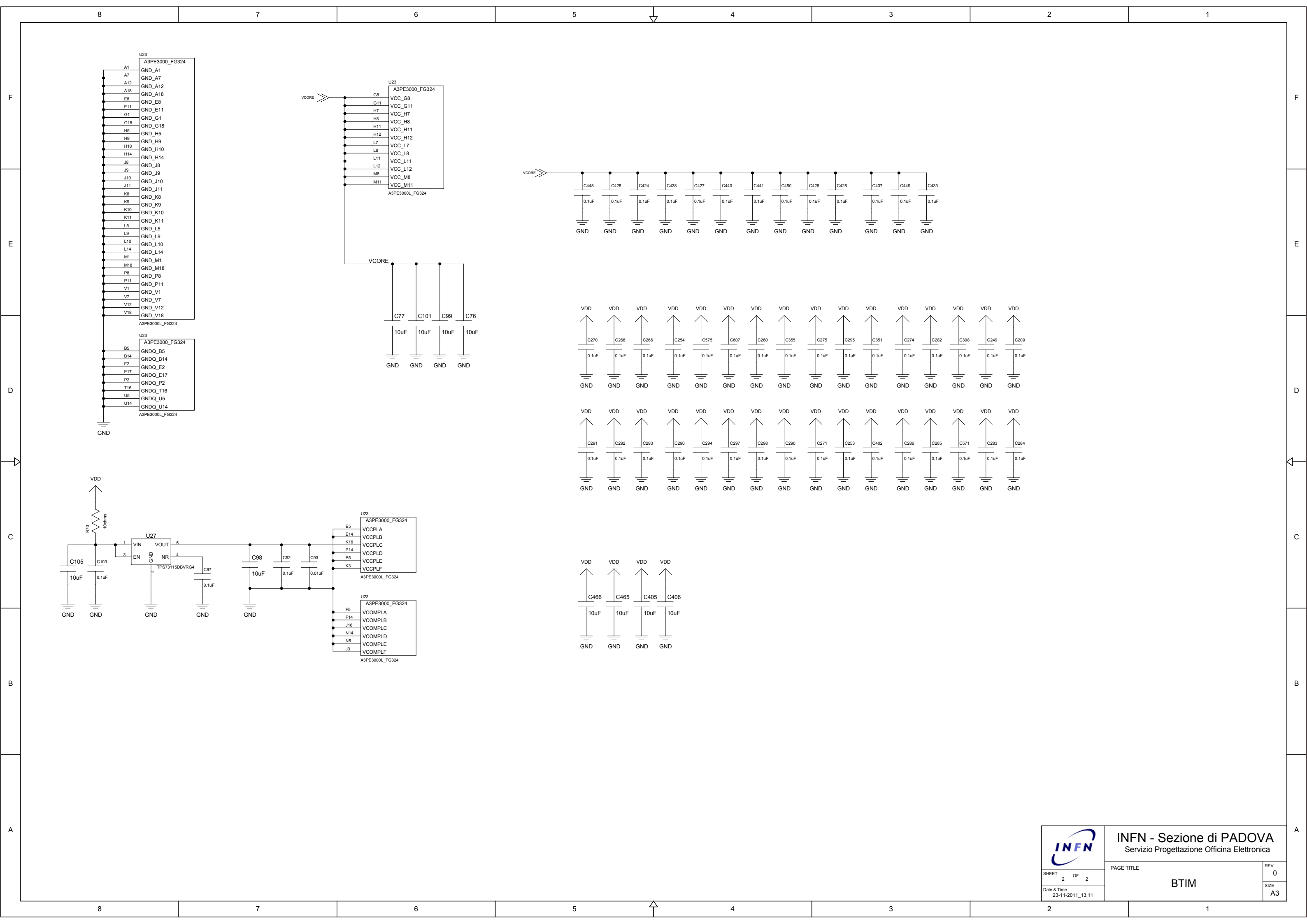

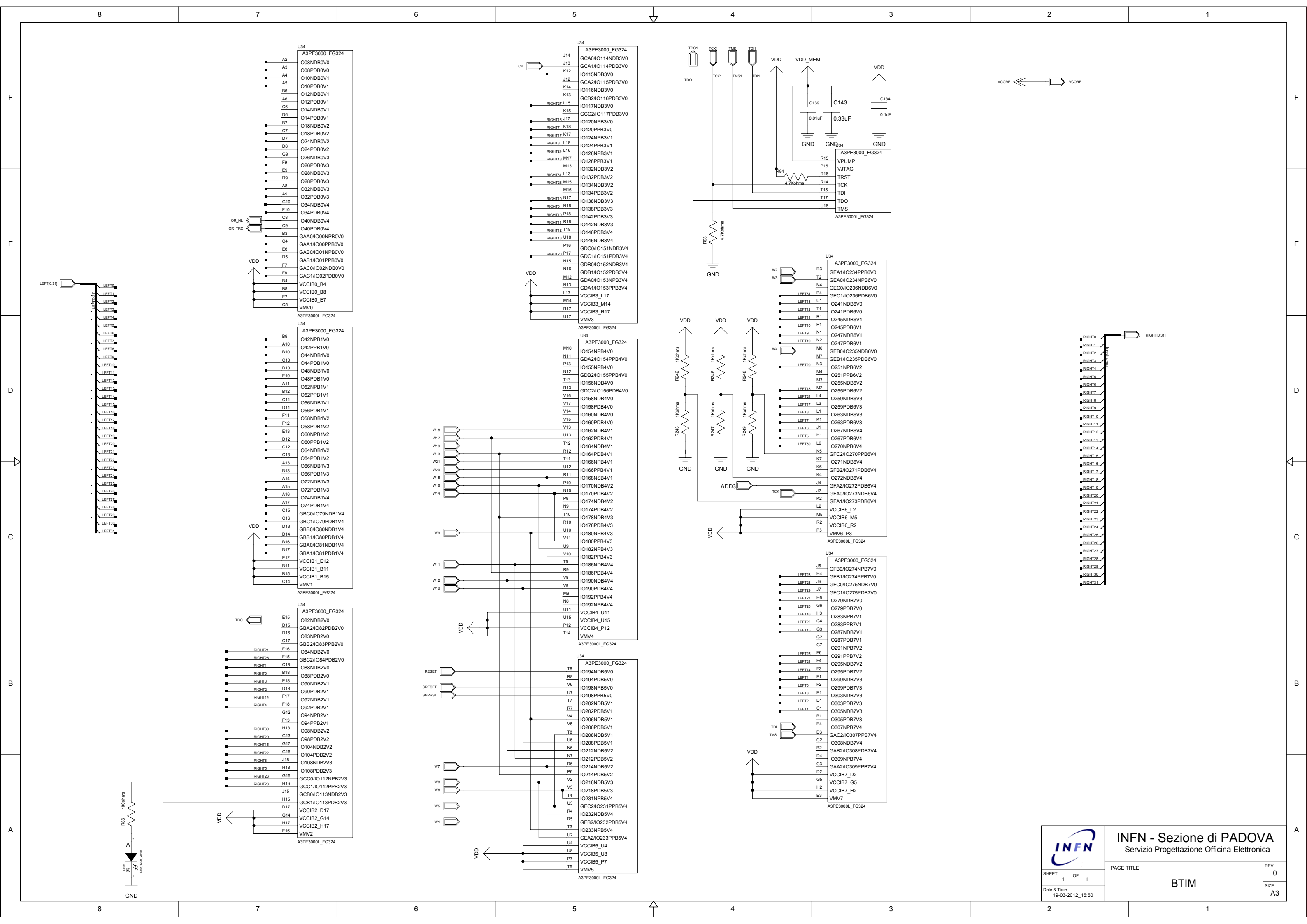

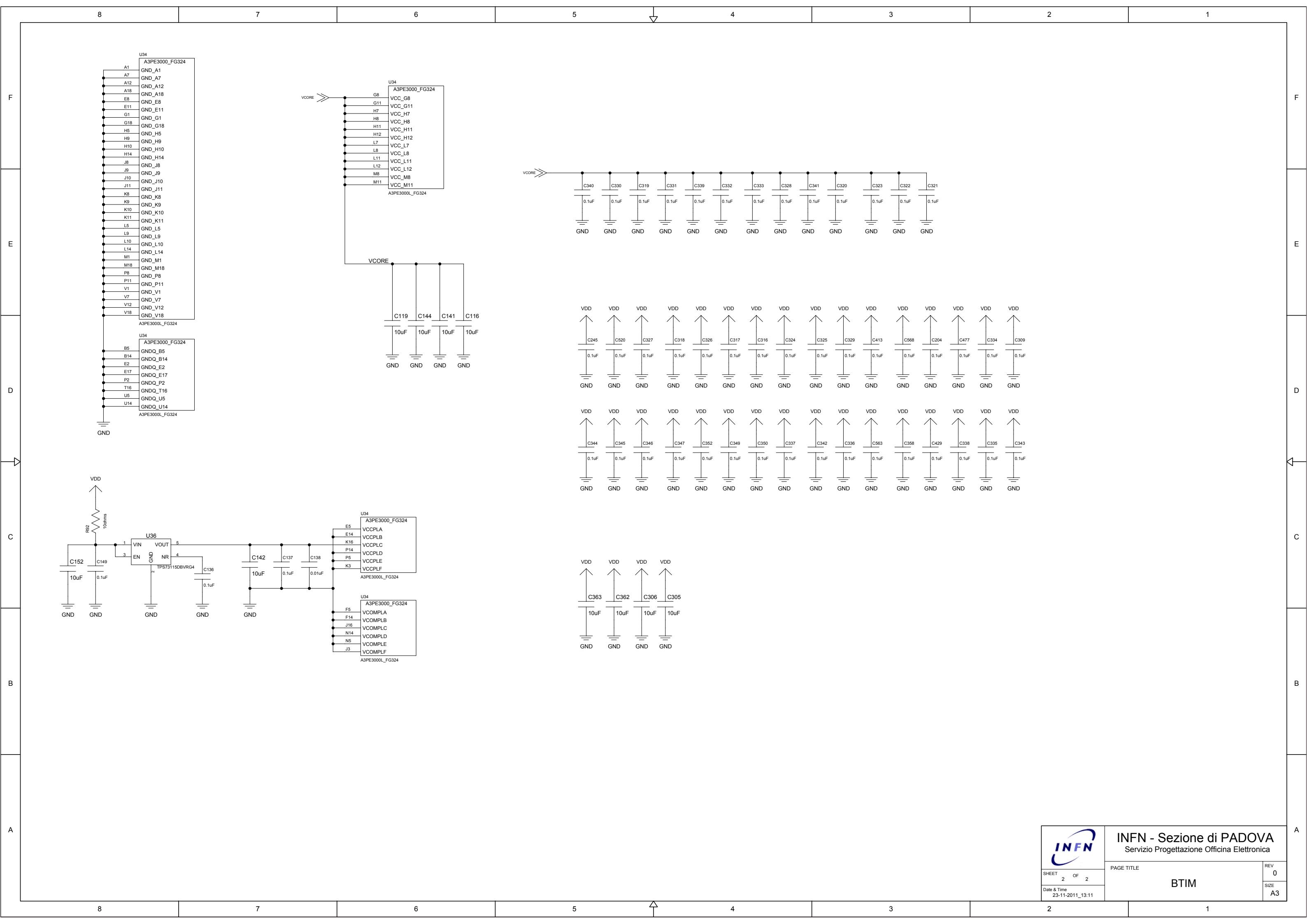

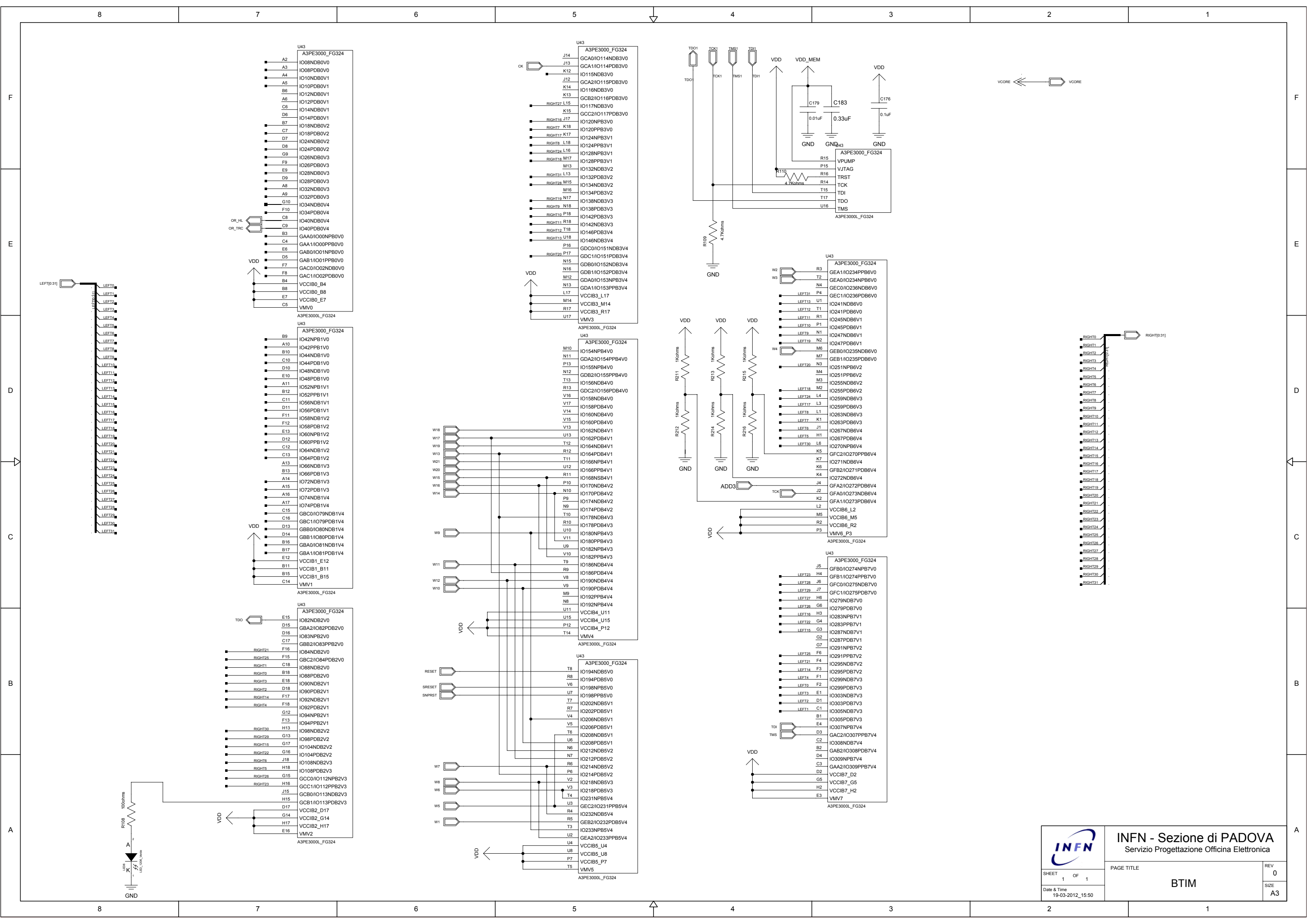

INFN - Sezione di PADOVA
 Servizio Progettazione Officina Elettronica

SHEET 1 OF 1
 Date & Time 19-03-2012_15:50

PAGE TITLE
 BTIM
 REV 0
 SIZE A3

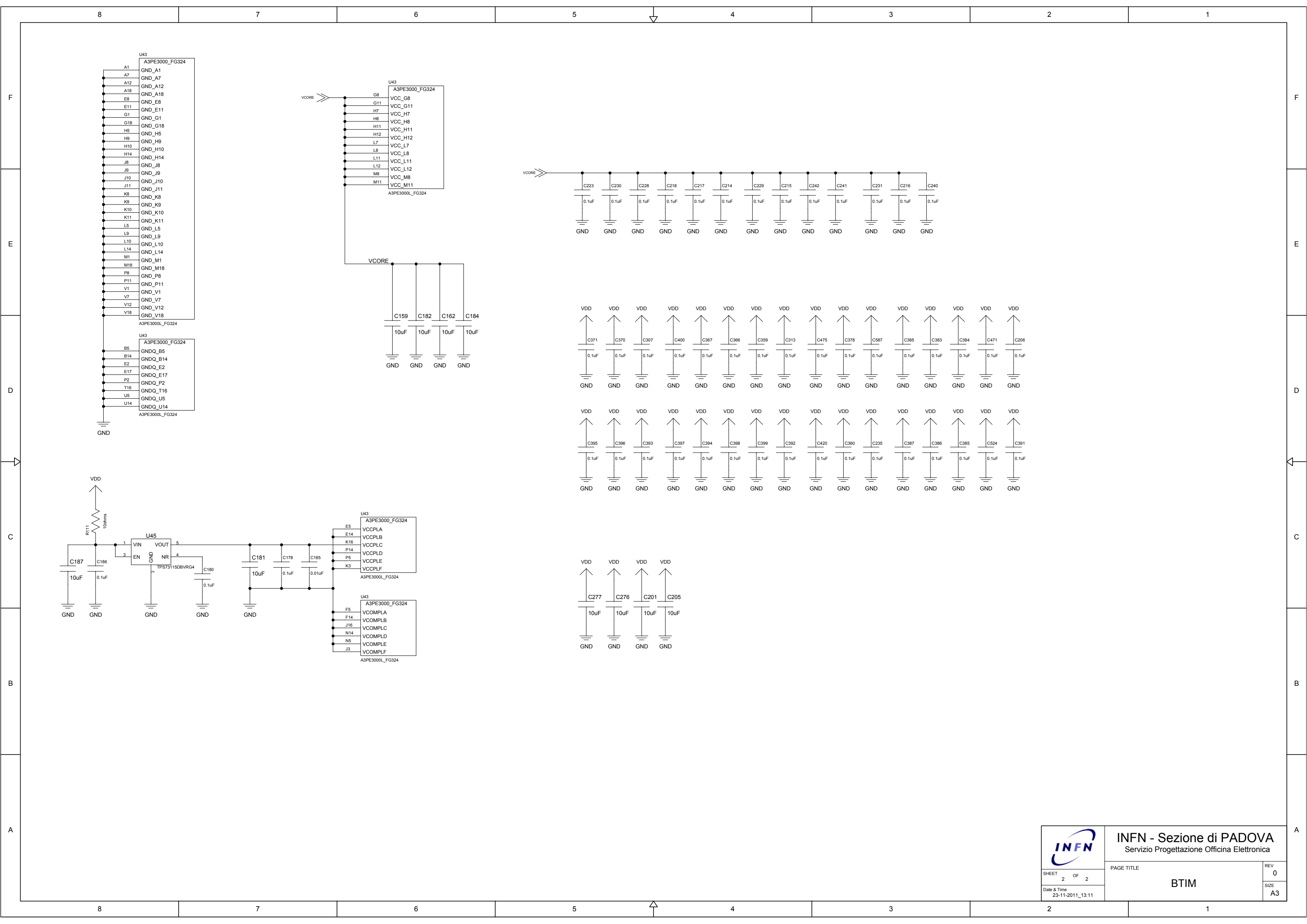

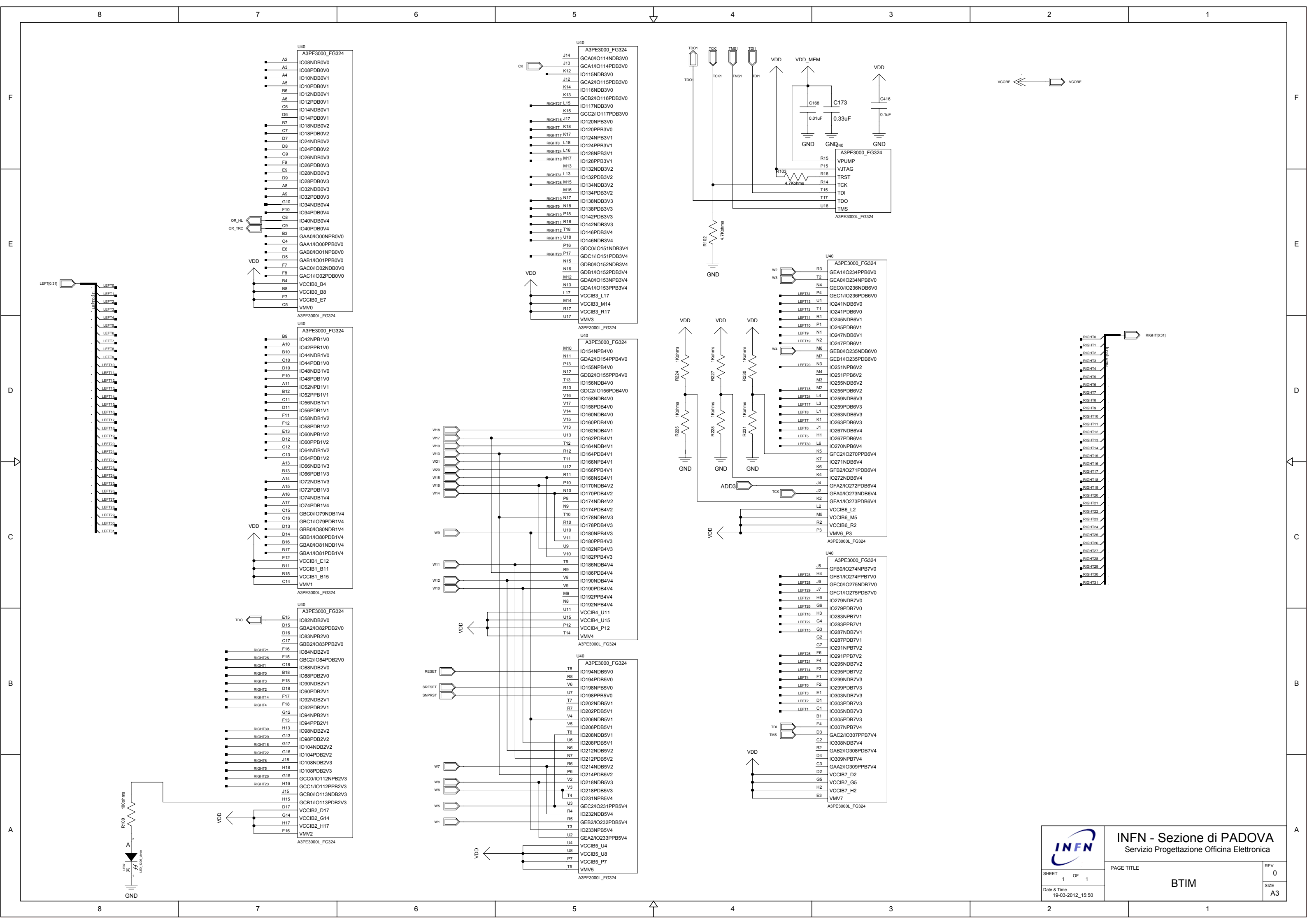

	INFN - Sezione di PADOVA Servizio Progettazione Officina Elettronica		REV 0
	PAGE TITLE BTIM		SIZE A3
	SHEET 1 OF 1		Date & Time 19-03-2012_15:50

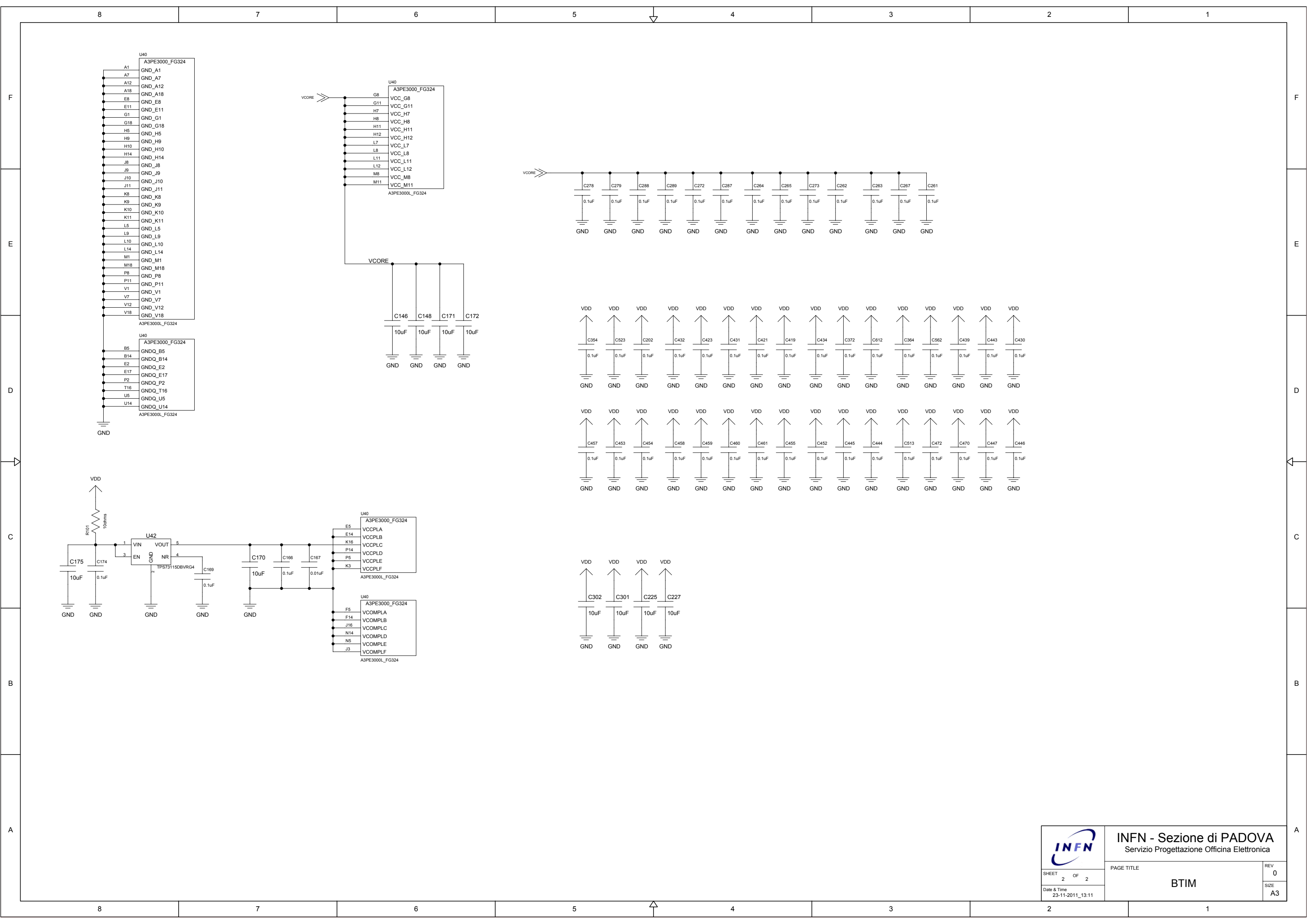

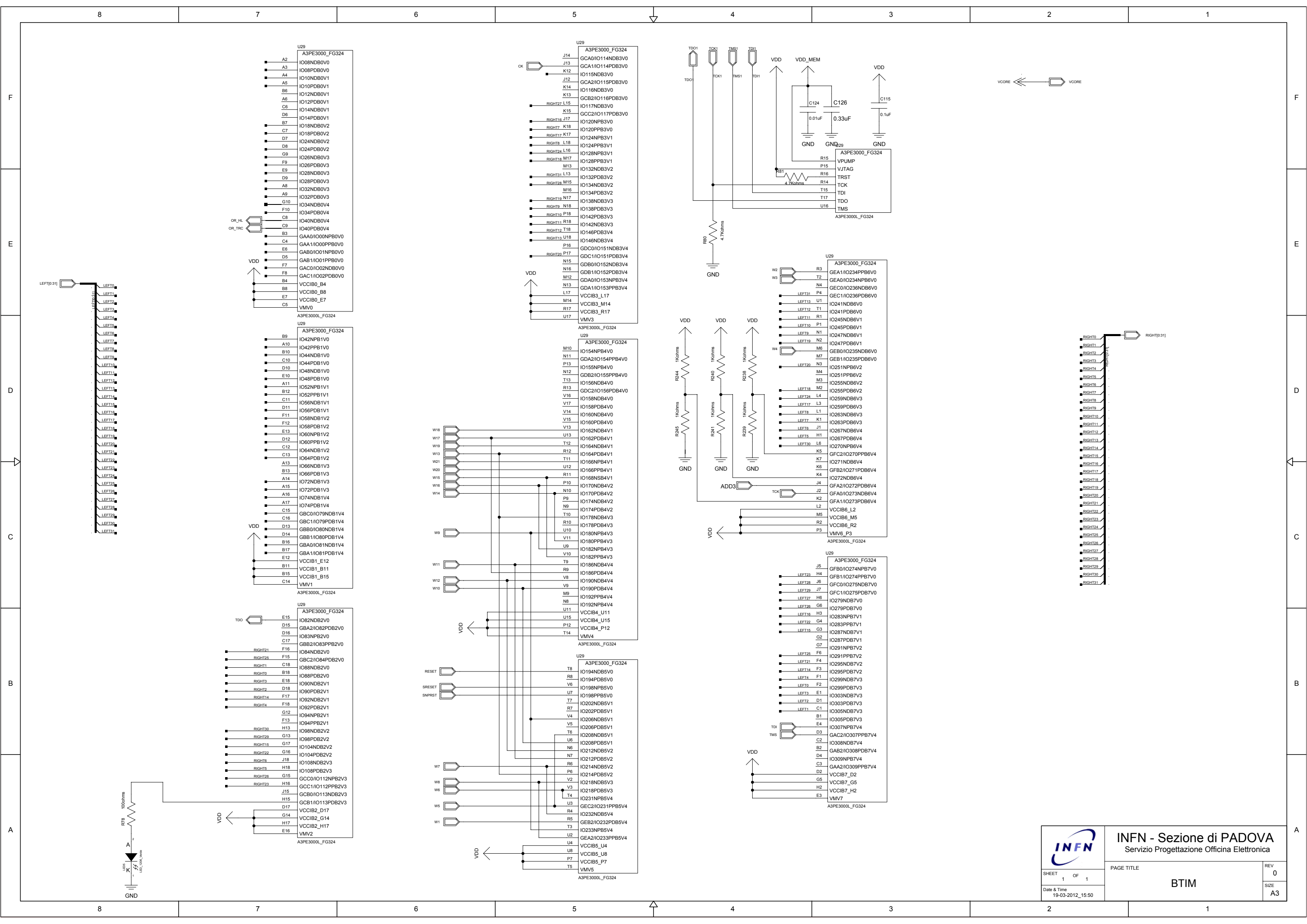

INFN - Sezione di PADOVA
 Servizio Progettazione Officina Elettronica

SHEET 1 OF 1
 Date & Time 19-03-2012_15:50

PAGE TITLE
 BTIM
 REV 0
 SIZE A3

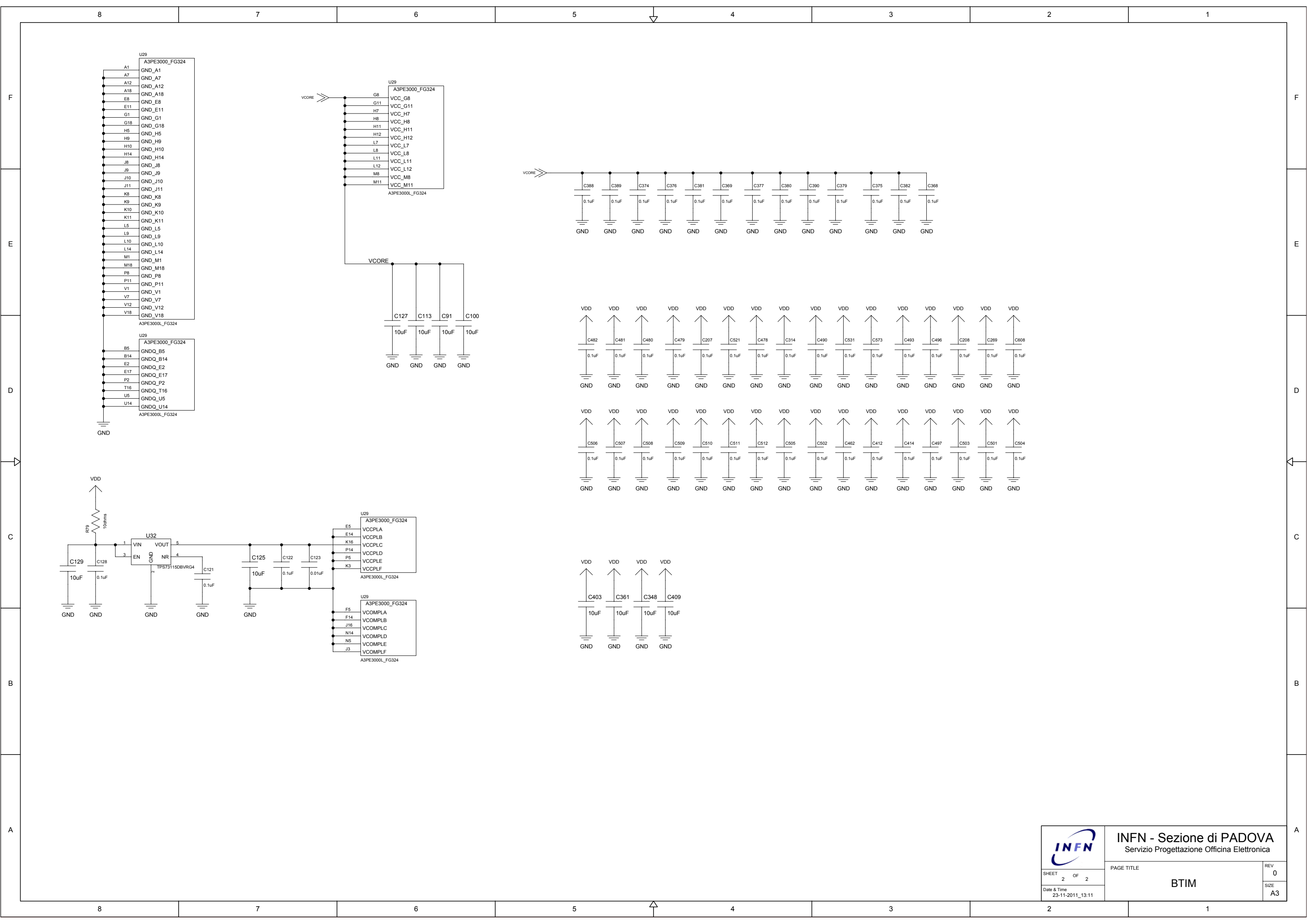

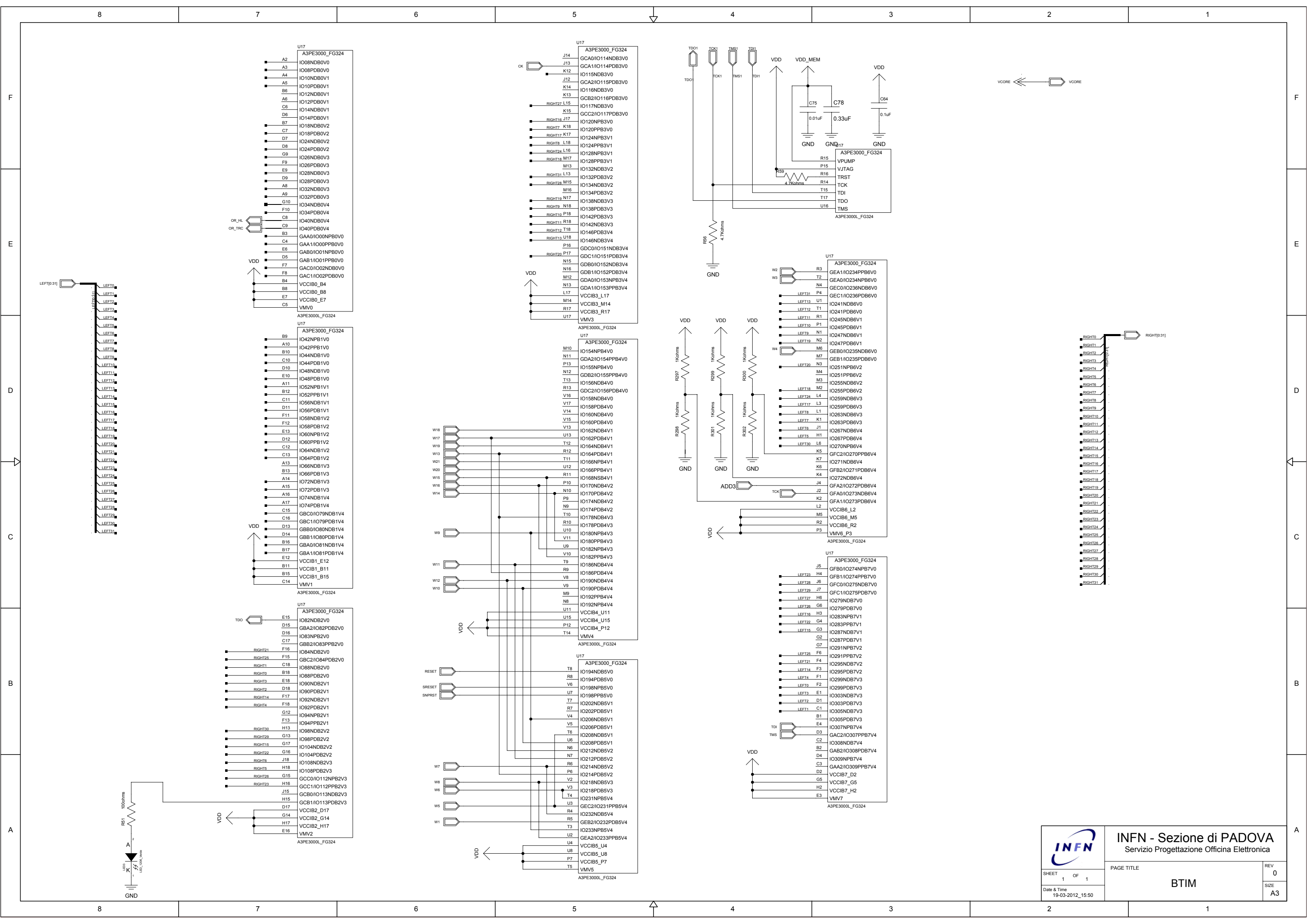

INFN - Sezione di PADOVA
Servizio Progettazione Officina Elettronica

SHEET 1 OF 1
Date & Time 19-03-2012_15:50

PAGE TITLE
BTIM
REV 0
SIZE A3

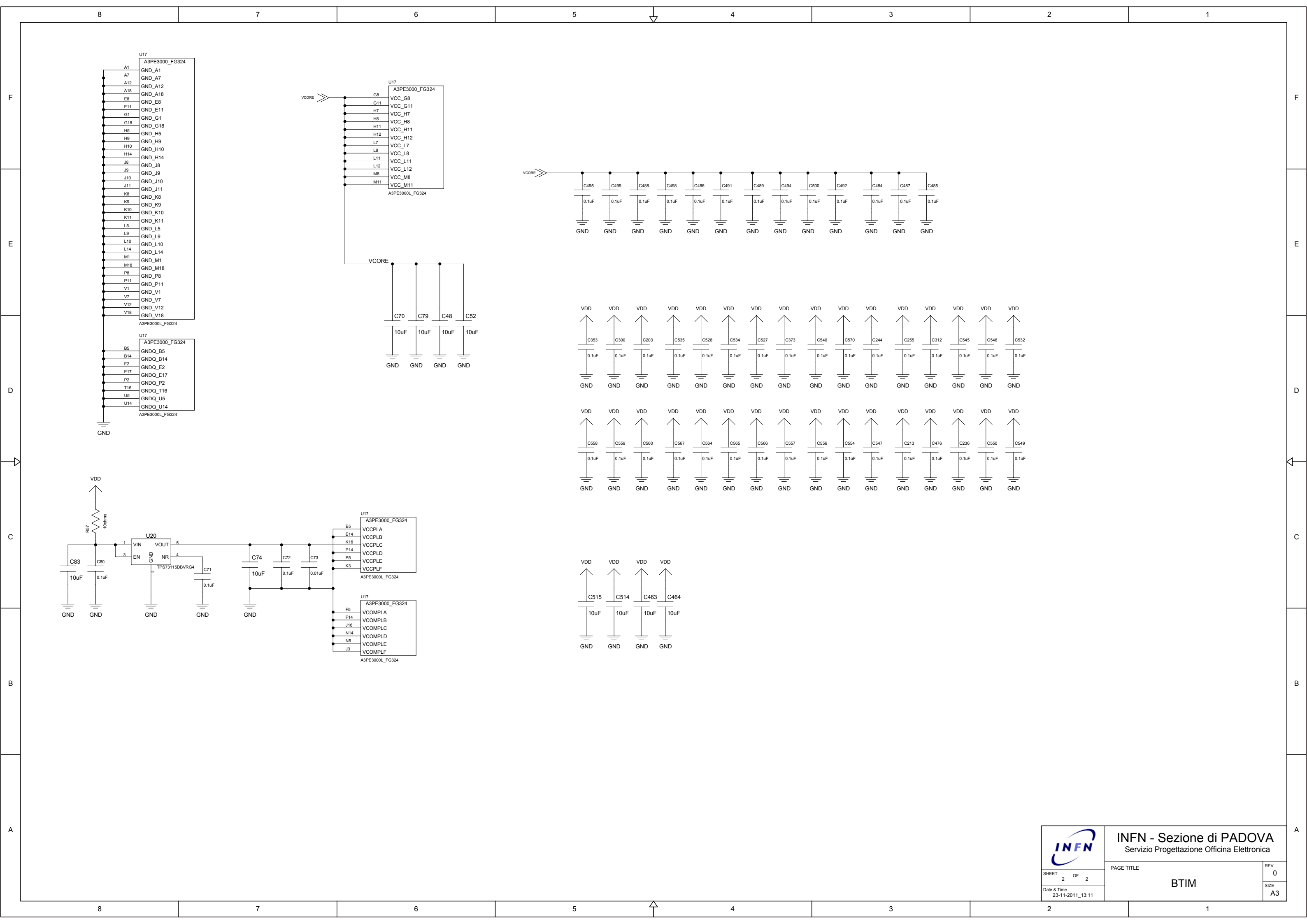

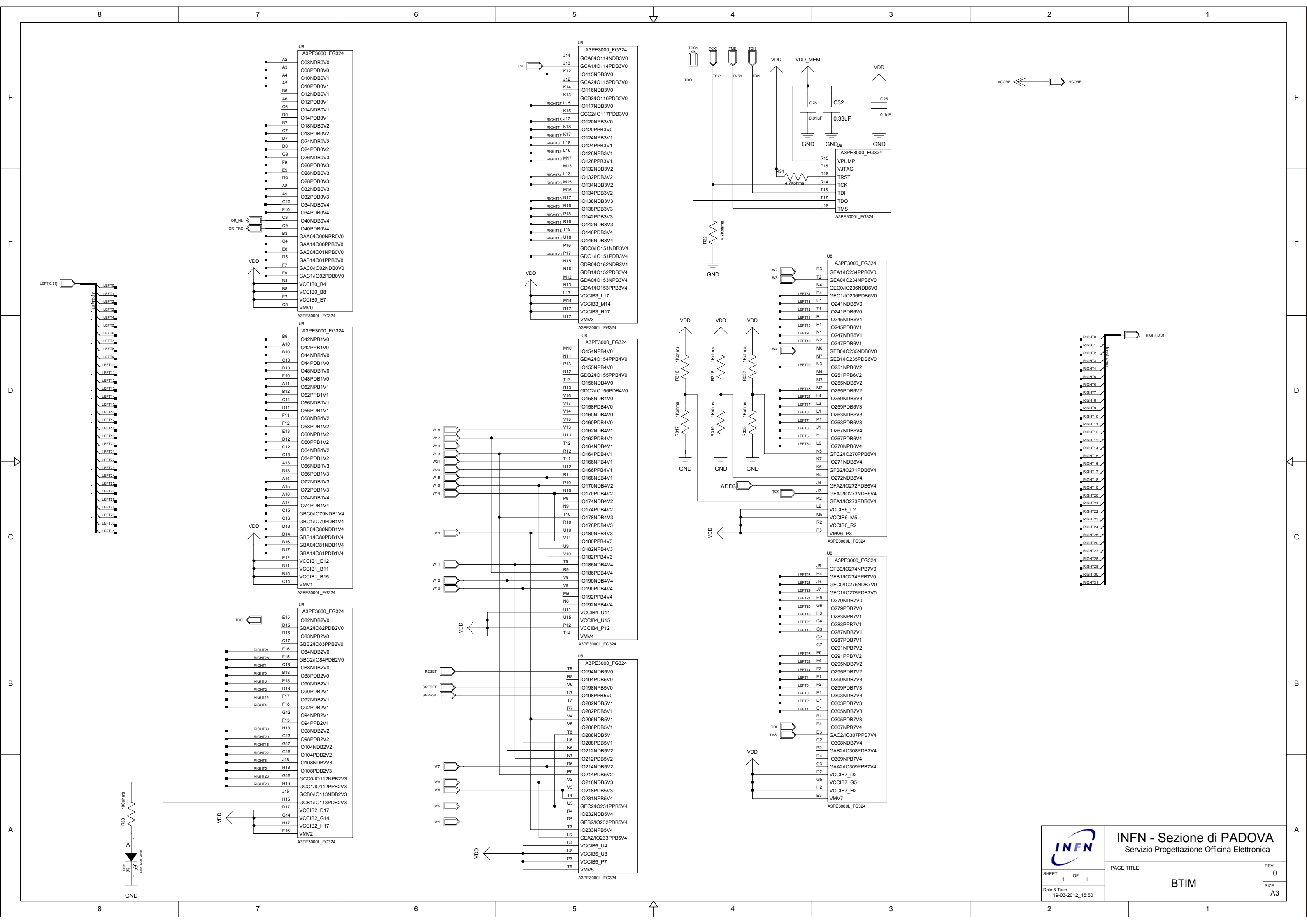

INFN - Sezione di PADOVA
Servizio Progettazione Officina Elettronica

SHEET 1 OF 1
Date & Time 19-03-2012_15:50

PAGE TITLE
BTIM
REV 0
SIZE A3

