

# Do we need New Physics?

## Present “Observational” Evidence for New Physics

- **NEUTRINO MASSES** 
- **DARK MATTER** 
- **MATTER-ANTIMATTER ASYMMETRY** 
- **INFLATION** 

# What kind of New Physics?

## At Hadron Collider

- High Mass Resonances ( $Z'$ ,  $W'$ , Graviton, Sneutrino, Axigluon)
- SUSY
- Technicolor
- New or Excited Fermions
- LeptoQuarks
- Extra Dimensions

# Search for New Physics

The breaking mechanism determines the **phenomenology** and the **search strategies**:

## Model Driven:

- theory driven, optimize analysis to the searches
- explore large region of parameter space

## Signature Based:

- search for unusual final states (not SM)
- optimize selections to minimize background
- interpret the results in terms of several models

## Global Searches:

- maximize the parameter space coverage
- less sensitivity but can give hint on possible deviation from SM

# Experimental Approach

- Lepton-only final states
  - $e/\mu$  identification well understood
  - $\tau$  id more complex
  - straightforward and efficient approach to search for anomalies
- MET and/or Photons
  - wealth of models and exotic process
  - detector effect are important, need to be understood
- Jets and Heavy Flavor
  - more complex signatures
  - Need to maintain high  $S/B$

# Model Driven Searches

# SUperSYmmetry

- Standard Model is theoretically incomplete
- SUSY: spin-based symmetry that relates Fermions to Bosons

$Q|Boson\rangle = Fermion$

$Q|Fermion\rangle = Boson$

- Define **R parity**:  $(-1)^{3(B-L)+2s}$   
 $R=1$  SM particles  
 $R=-1$  MSSM partners

- No SUSY particles found yet
  - SUSY must be broken  
 -> models depend on many parameters even in "minimal" models

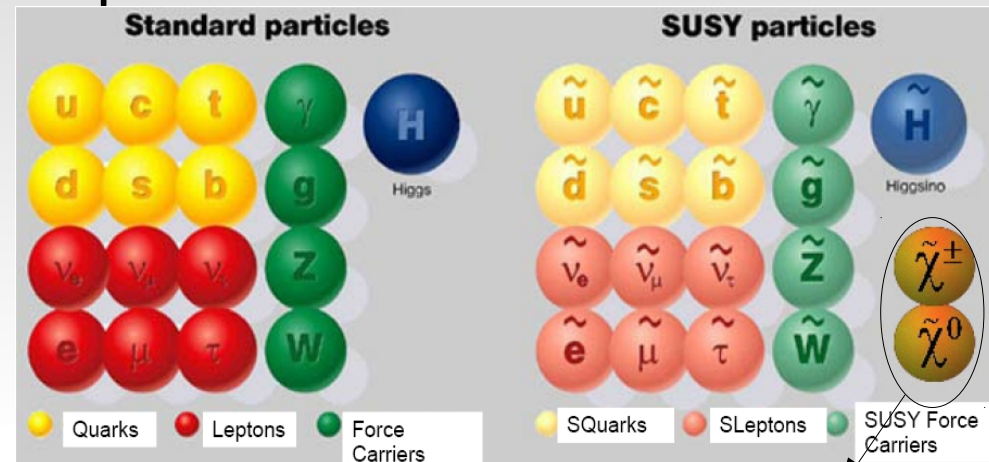

gaugino/higgsino mixing gives chargino and neutralino

If R conserved in production and decay provides Dark Matter Candidate (Lightest Supersymmetric Particle)

# SuSy Production

Highest production cross section from squark and gluino

Electroweak chargino/neutralino production accessible

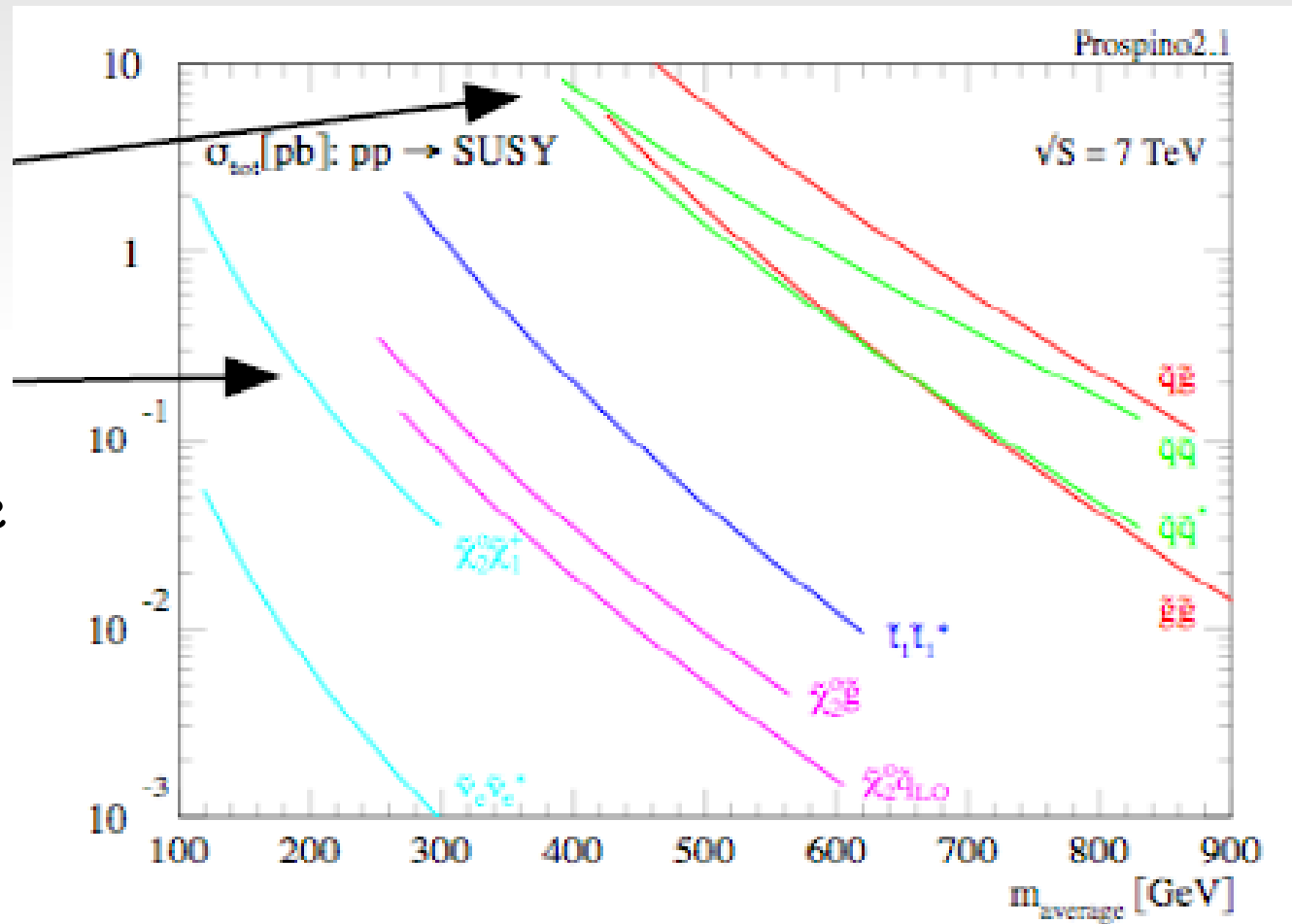

# SuSy Particles

$$m_0 = 100 \text{ GeV}, m_{1/2} = 300 \text{ GeV}$$

$$A_0 = -300, \tan \beta = 6, \mu > 0$$

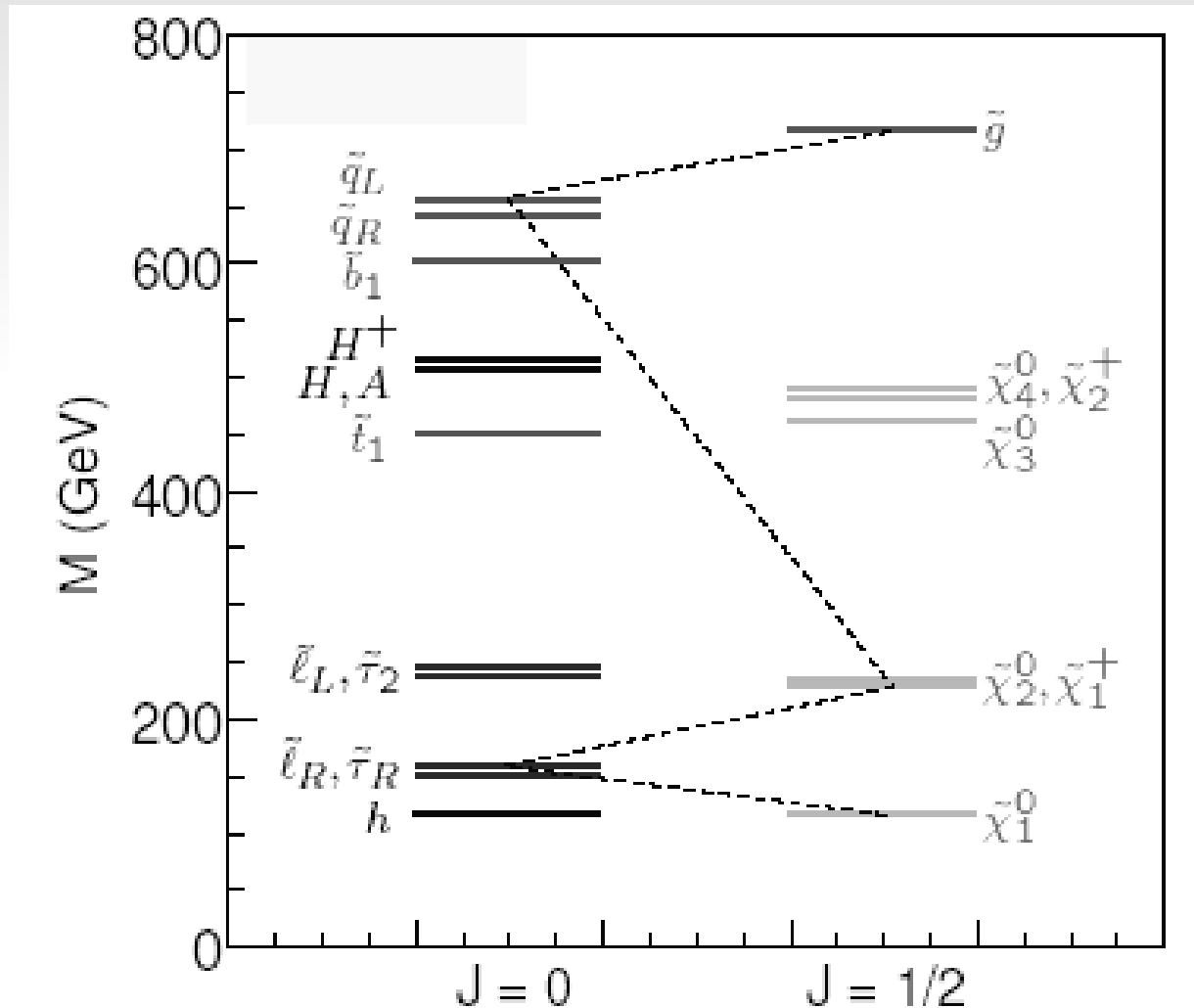



# SuSy Decay

## Superparticle decays

**Gluino decays:** always to  $q\bar{q}$ .

If  $M_{\tilde{g}} < M_{\tilde{q}}$ , then gluino will decay via an off-shell squark:  
3-body decays,  $\tilde{g} \rightarrow q\bar{q}^* \rightarrow q\bar{q}\tilde{N}_i$  or  $q\bar{q}\tilde{C}_i$

**Squark decays:**

To  $q\tilde{g}$  (strong coupling) if kinematically allowed.

Otherwise  $q\tilde{N}$  or  $q\tilde{C}$  or (for 3rd gen.)  $q\tilde{H}$ .

Decay branching fractions controlled by squark and -ino compositions.

**Slepton decays:** to  $\ell\tilde{N}$  or  $\ell\tilde{C}$  ( $\ell = \ell^\pm$  or  $\nu$  as appropriate)

**Neutralino and chargino decays:** to  $\ell\tilde{\ell}$  or  $q\bar{q}$ ,  
or to gauge or Higgs boson + lighter neutral-/charg-ino

Typically get **decay chains**, which always end with the LSP.

For example:

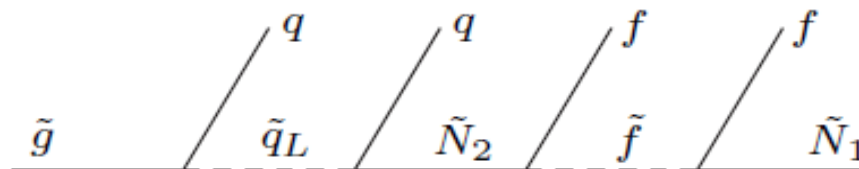

DOI:10.1017/9781009100000.009

# SuSy Searches Signatures

Assume  $R^P$  conservation and  $\tilde{\chi}_1^0$  is LSP (light stable particle)

Signatures depend on the decay chain but ending with a LSP  $\rightarrow$  MET:

- MET (LSP +  $\nu$ )
- isolated leptons from  $W/Z$  or  $\tilde{\chi}^\pm$
- jets

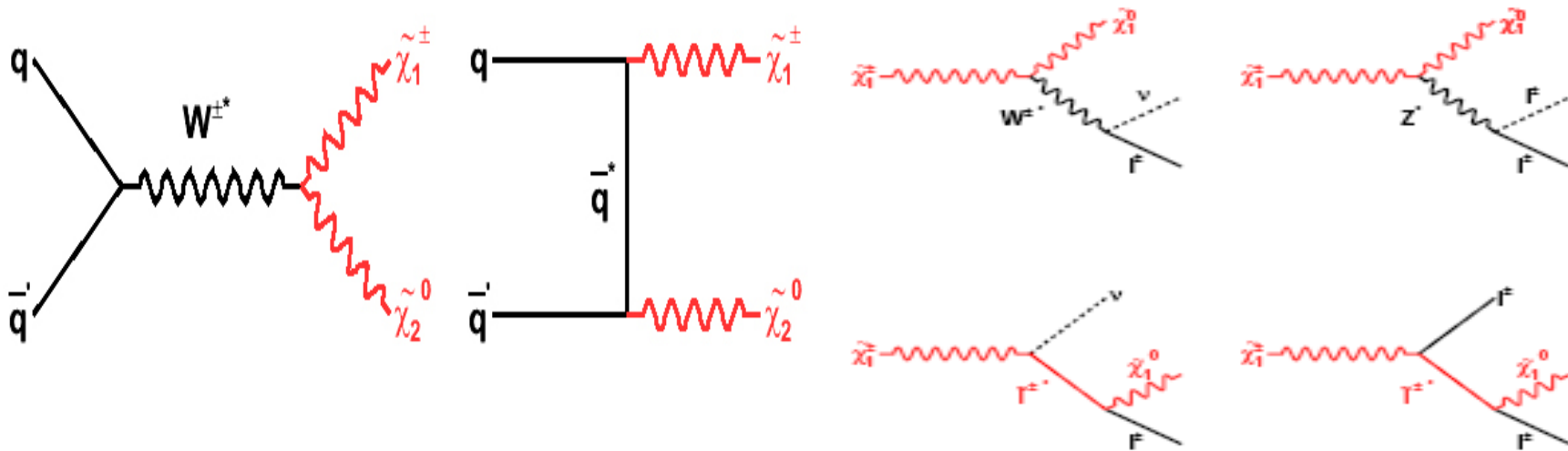

# Same Sign di-lepton SuSy Searches

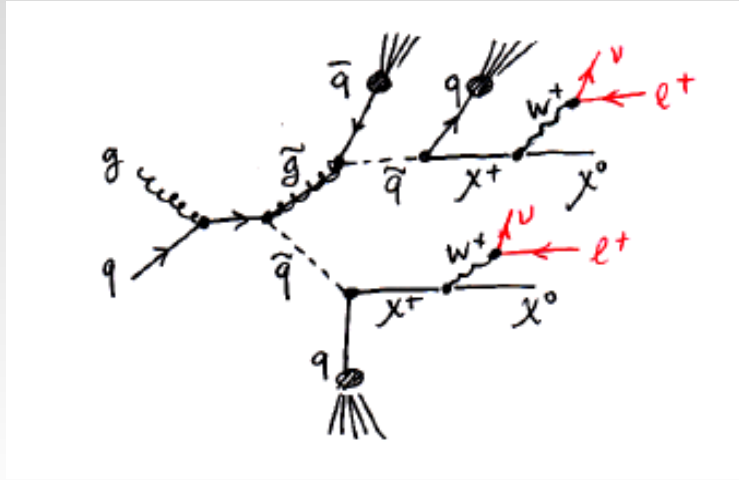

Production of squark and gluino

Event: Same sign leptons, MET jets

Background from lepton+jets, but rare processes like  $WW, WZ, ZZ$  become important

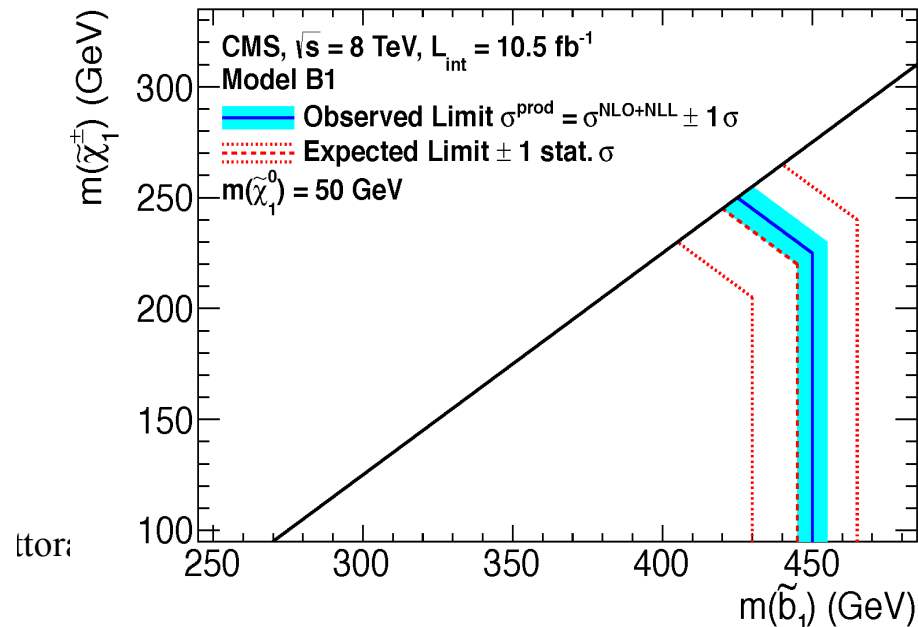
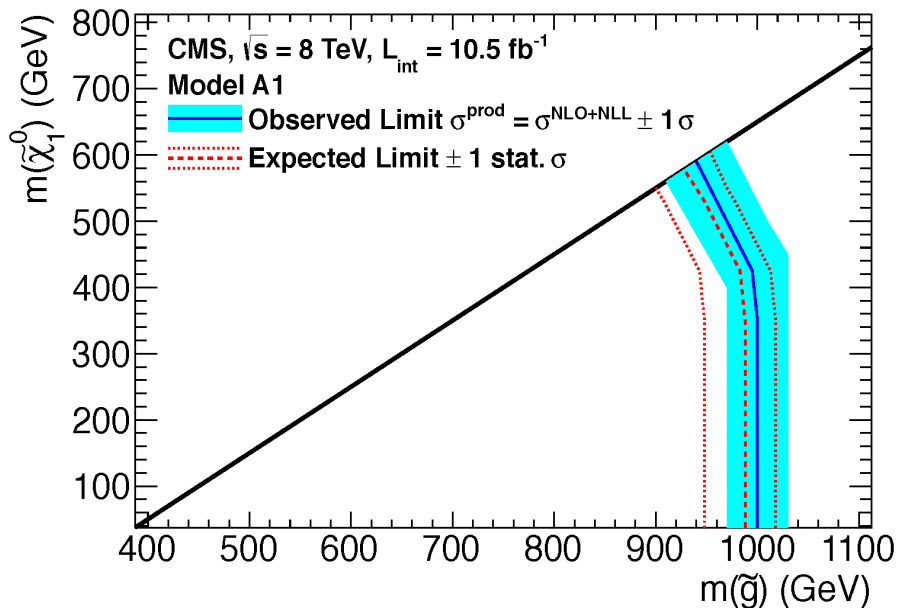

# Multi-lepton SuSy Searches

Multi-lepton production is sensitive to many models

Charginos can decay: sleptons ( $\tilde{\nu}\ell$ ), sneutrinos ( $\tilde{\ell}\nu$ ) or  $W$  bosons ( $W^\pm \tilde{\chi}_1^0$ ),  
 neutralinos can decay:  $\tilde{\ell}\ell$ ,  $\nu\tilde{\nu}$ , or  $Z \tilde{\chi}_1^0$

Signal Event: 3 or 4 leptons, MET

Background:  $WW, WZ, ZZ, tt, Z$ +jets, Drell-Yan  
 Direct chargino/neutralino production

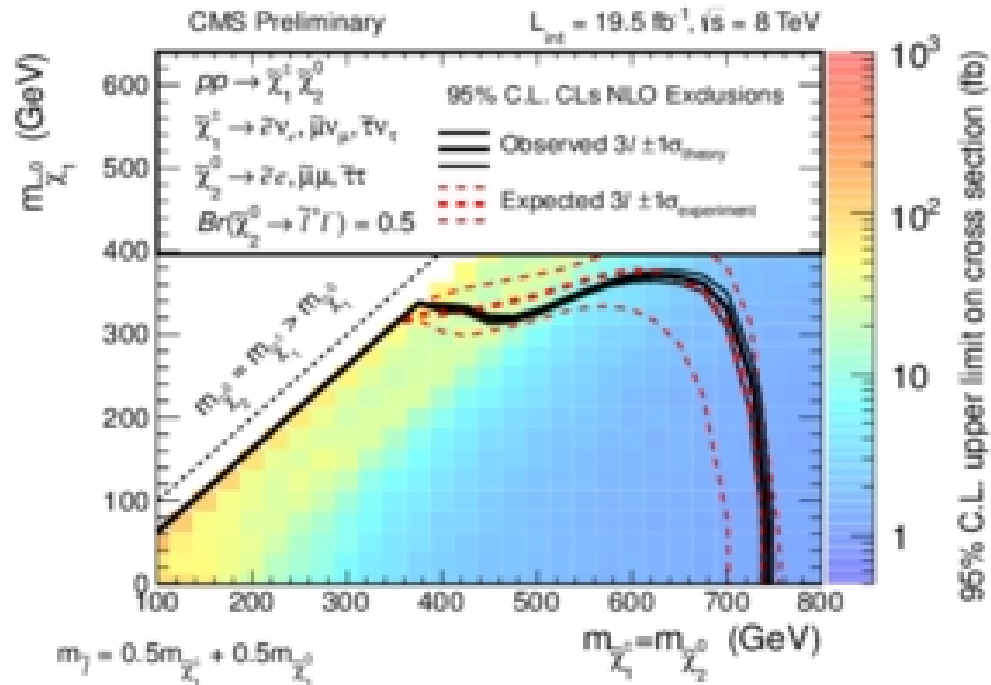

# Third SuSy Generation Searches

The third SuSy generation is somehow special:

- should be light for SuSy naturalness
- stop, sbottom, stau masses can be lower than other generation

Several possible events selection that will give different sensitivity to different processes.

Consider as example: two same-sign lepton + b-jets

- 2 same-sign lepton
- 2 b-tagged jets
- MET

Define many signal region (SR) for different kinematic

Main background due to  $t\bar{t}$

# Top Squark Searches

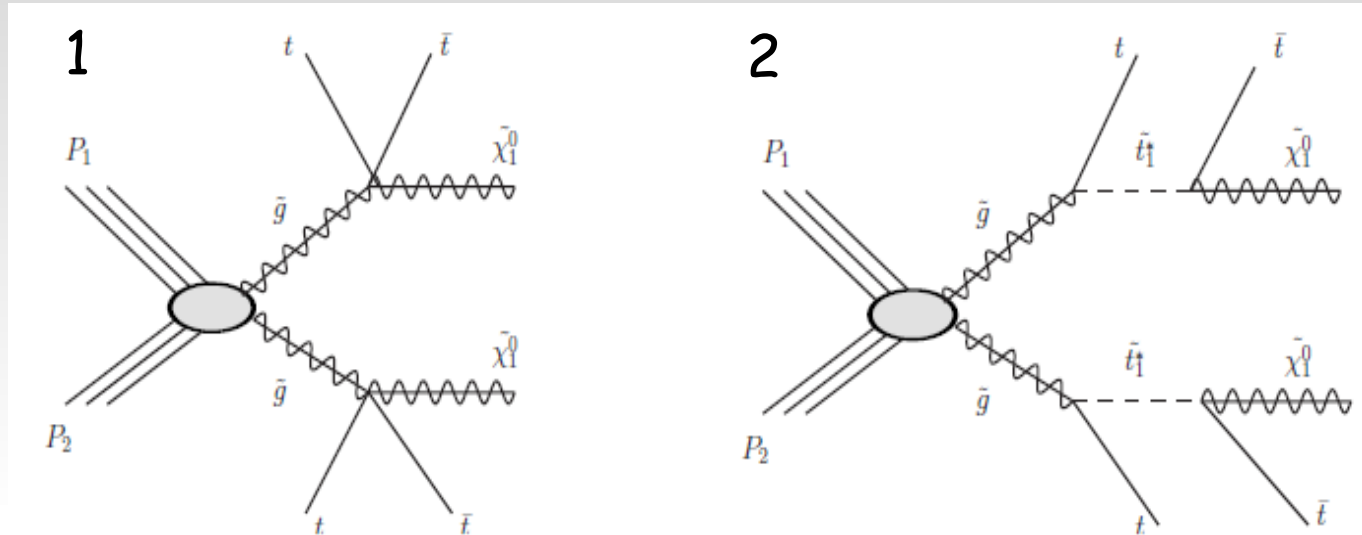

Possible searches:

1. three-body gluino decay mediated by virtual stop:  $\tilde{g} \rightarrow t\bar{t}\tilde{\chi}_1^0$
2. two-body gluino decay to a top-stop pair:  $\tilde{g} \rightarrow t\tilde{t}_1$ ,  $\tilde{t}_1 \rightarrow t\tilde{\chi}_1^0$

In 1. the assumption is that the gluino is lighter than all the squarks and the stop is the lightest squark.

In 2. the stop is similar to 1. but with the stop so light to be on-shell

Final states with  $t\bar{t}\tilde{\chi}_1^0\tilde{\chi}_1^0$ : 4b-jets, high Pt leptons, MET

# Top Squark Searches Results

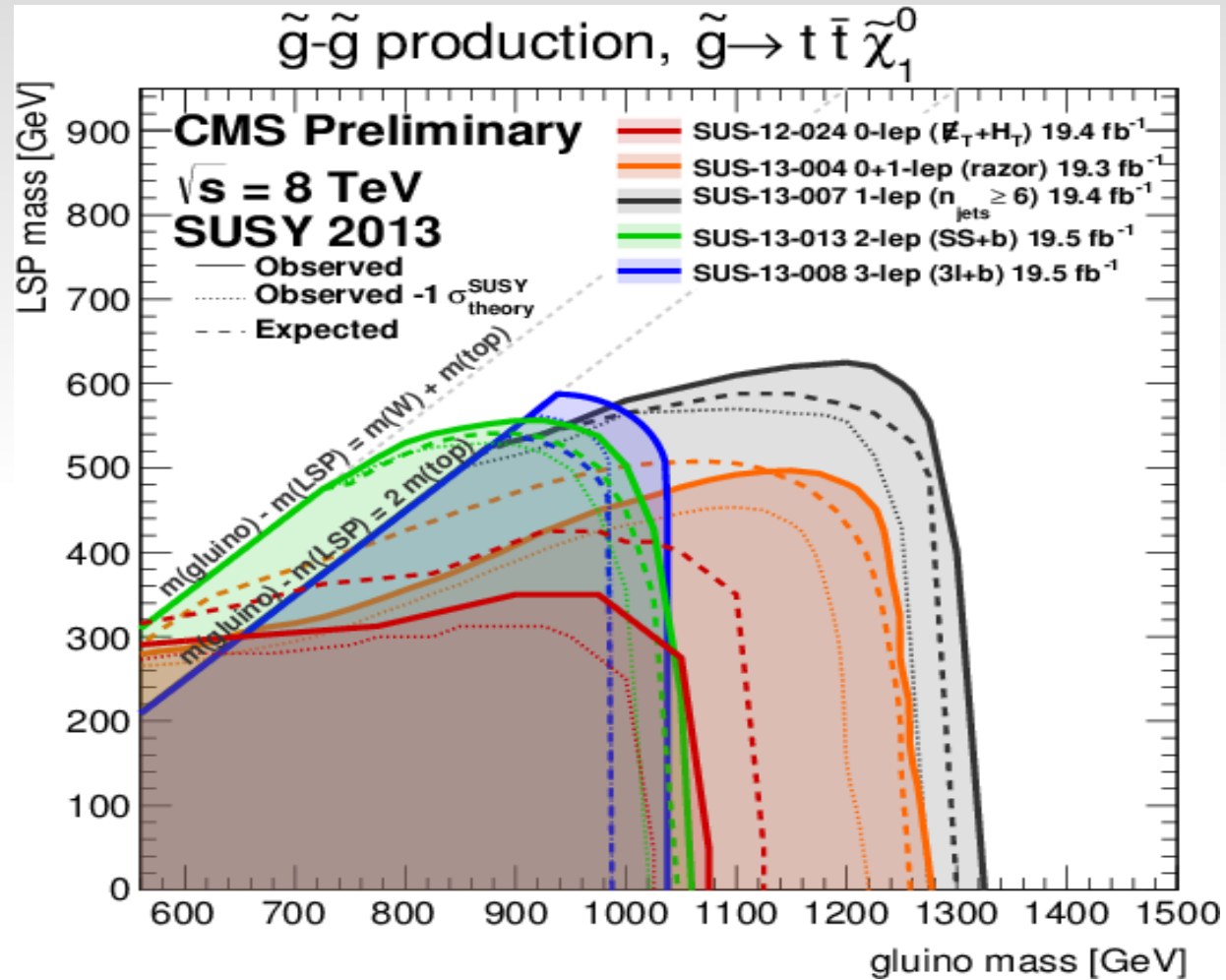

# Bottom Squark Searches

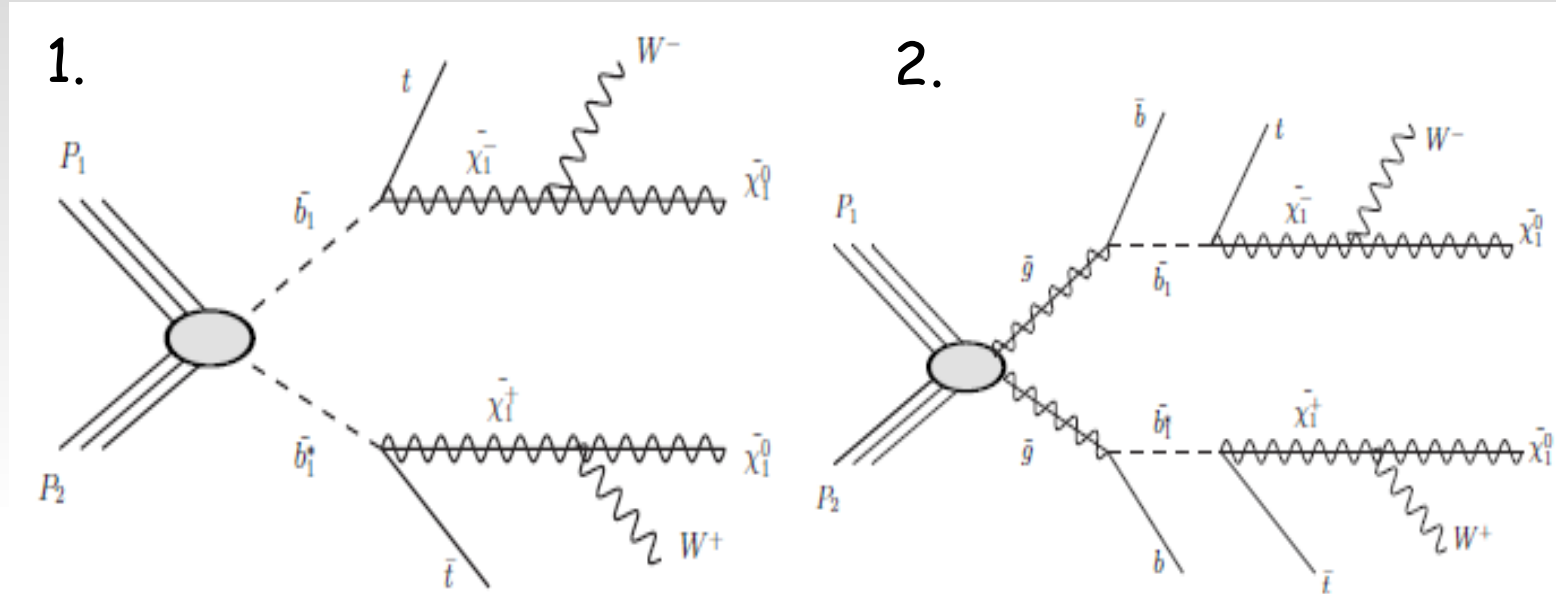

1.  $pp \rightarrow \tilde{b}_1 \tilde{b}_1^* \tilde{b}_1 \rightarrow t \tilde{\chi}_1^-$
2.  $pp \rightarrow \tilde{g} \tilde{g}$  or  $pp \rightarrow \tilde{g} \tilde{b}_1$  with  $\tilde{g} \rightarrow \tilde{b}_1 \bar{b}$

Final states are:

1.  $t\bar{t}W^+W^-\tilde{\chi}_1^0\tilde{\chi}_1^0 \rightarrow$  b-jets, leptons, MET

2. mixture of  $t\bar{t}WW + \tilde{\chi}_1^0\tilde{\chi}_1^0 \rightarrow$  b-jets, leptons, MET



# Bottom Squark Searches Results

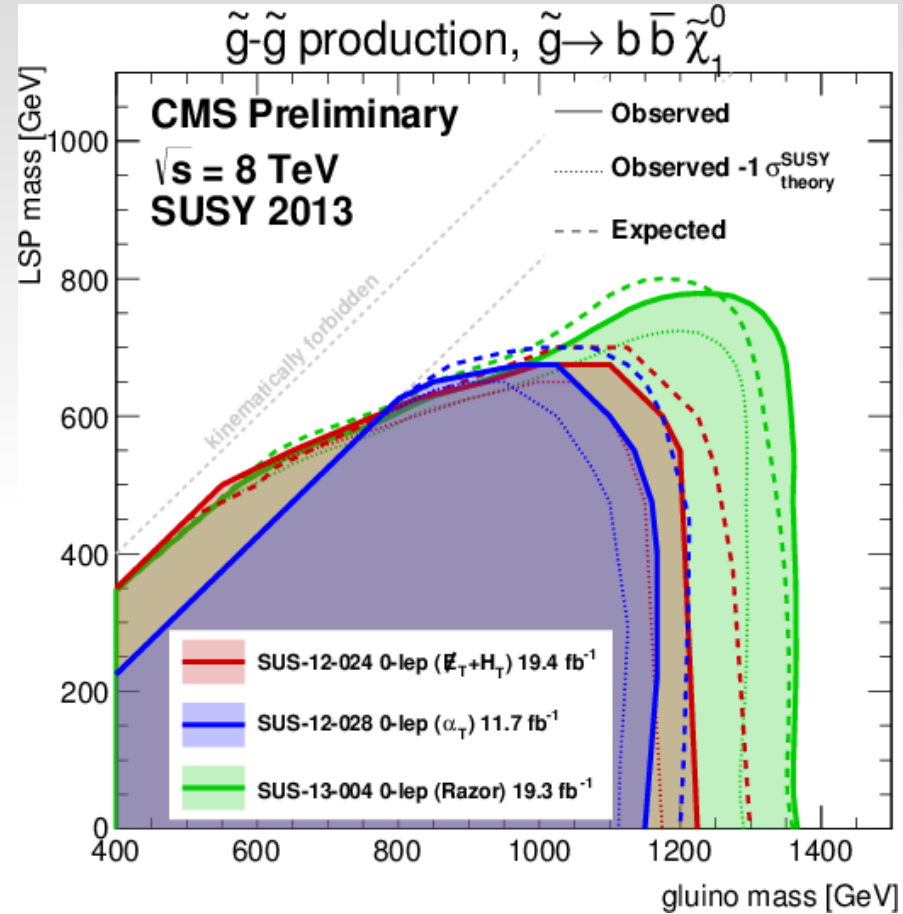

# SUSY Searches Summary

## Summary of CMS SUSY Results\* in SMS framework

SUSY 2013

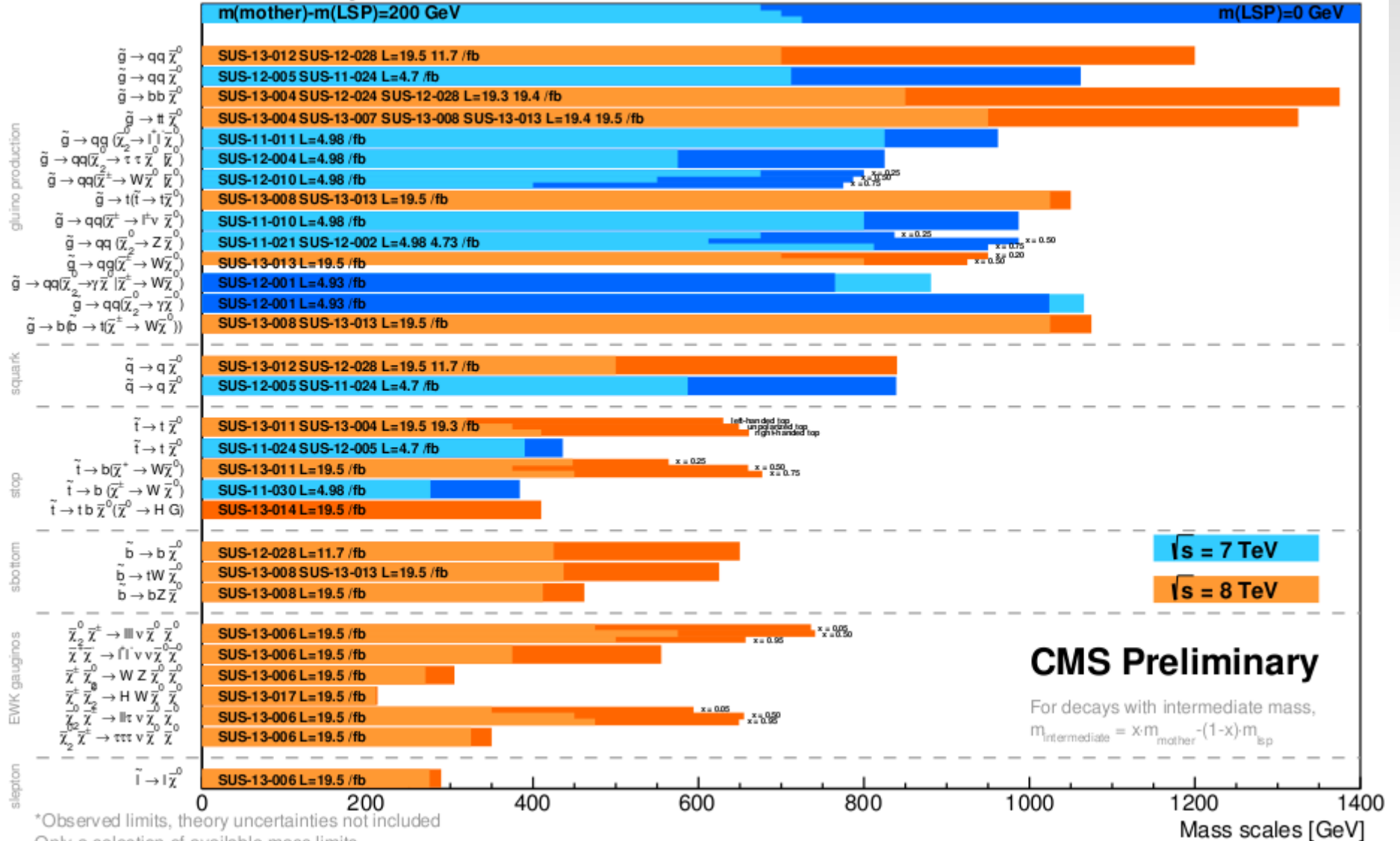

\*Observed limits, theory uncertainties not included  
 Only a selection of available mass limits  
 Probe \*up to\* the quoted mass limit

# Signature Based Searches

# Di-leptons Searches: Starting Point

Search for resonances or excess in  $ee/\mu\mu$  in the high mass region

- lepton id well under control
- Z peak used as reference
- clean events

Several extensions of SM predict:

- heavy spin-1 neutral gauge bosons such as  $Z'$ ,  $Z^*$
- techni-mesons
- spin-2 Randall-Sundrum gravitons,  $G^*$ , with a narrow intrinsic width  
 $K/M_{Pl} < 0.1$   $k$ =space-time curvature in extradimensions,  $M_{Pl} = M_{Plank}$  reduced

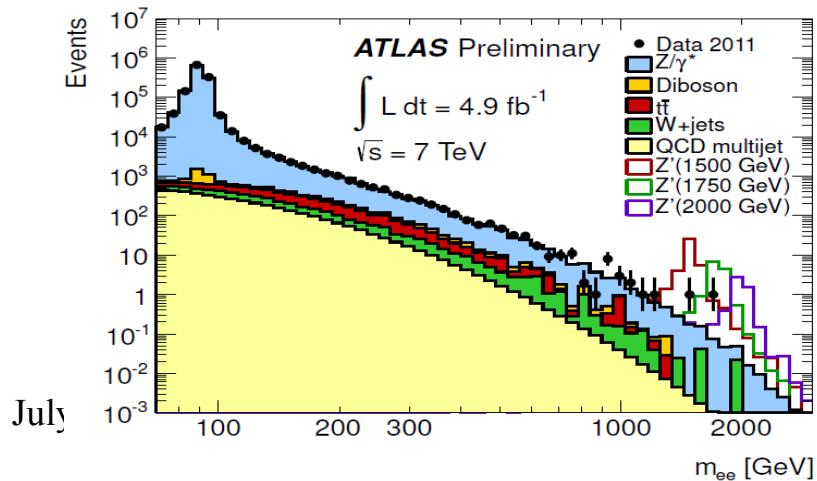
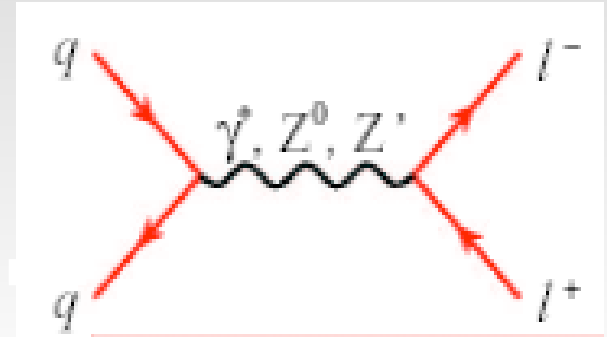

Dottorato 2

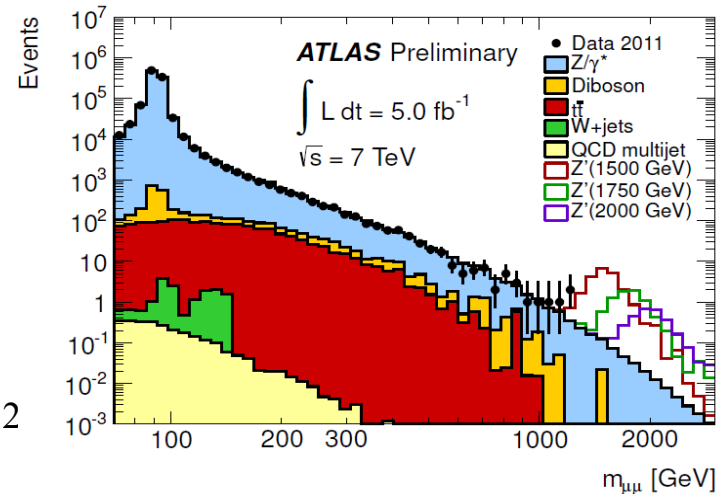

20

# New Physics Searches Di-leptons Resonances

## Analysis Method

- understand very well data spectrum in term of SM process
- calculate new signal acceptances and trigger efficiencies
- derive the number of expected new physics events
- if no events found in data calculate 95% CL cross section limit and set particle mass limit

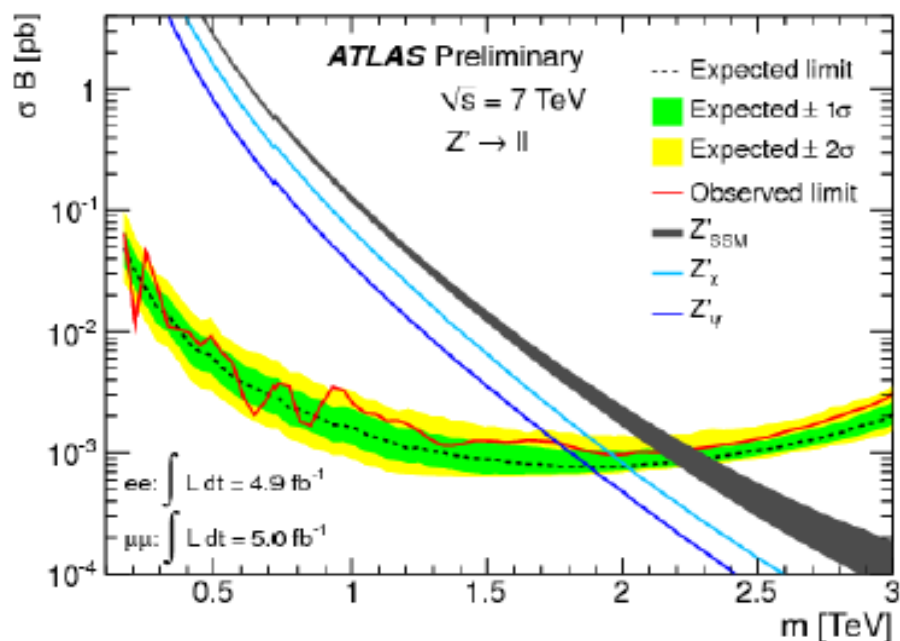

## Atlas Limits:

- Sequential SM:  $m_{Z'} > 2.21 \text{ TeV}$
- RS graviton,  $k/M_{\text{Pl}} = 0.1$ :  $m_G > 2.16 \text{ TeV}$

# New Physics Searches Di-leptons Excess

Excess of events not forming a resonance  $\rightarrow$  Physics beyond SM

Composite quarks and leptons with at least one common constituent, have an effective four-fermion contact interaction at energies well below the compositeness scale which alter the Drell-Yan production

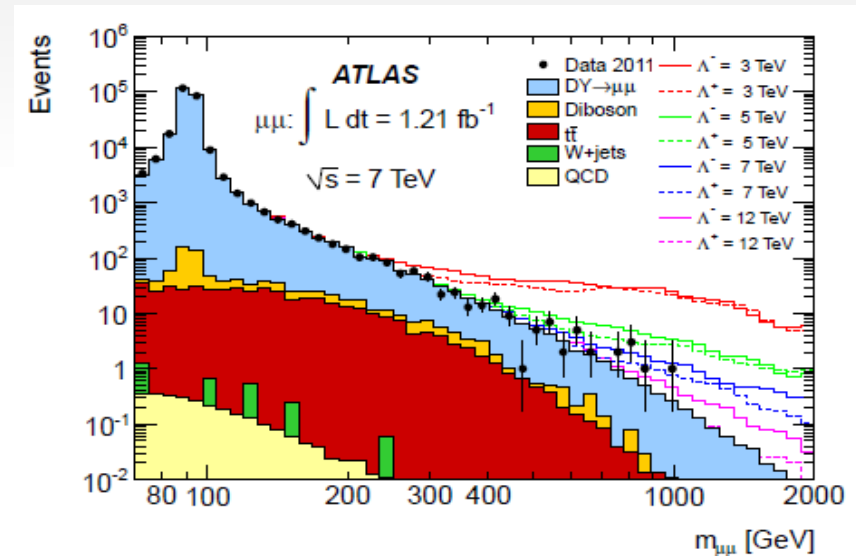
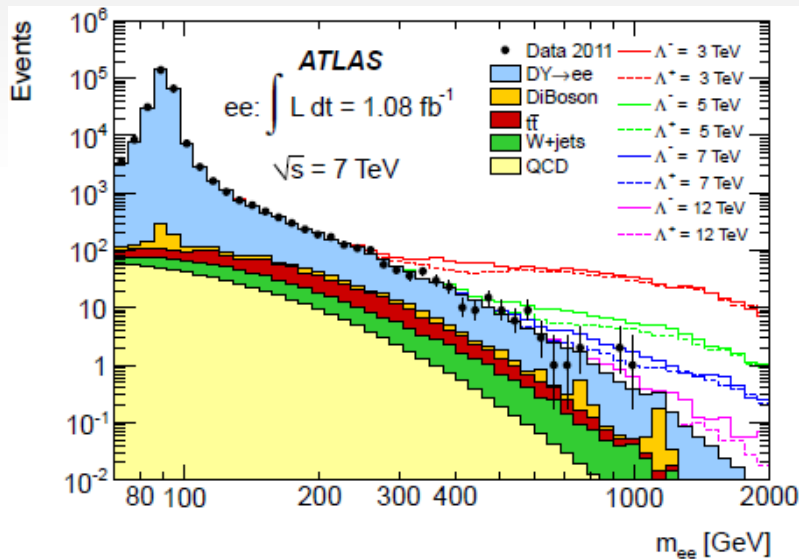

Limit:

- constructive interaction  $\Lambda^- > 10$  TeV ( $ee$ )  $\Lambda^- > 8$  TeV ( $\mu\mu$ )
- destructive interaction  $\Lambda^+ > 9.4$  TeV ( $ee$ )  $\Lambda^+ > 7$  TeV ( $\mu\mu$ )

# New Physics Searches Di-leptons Excess

Models with extended space-time structure predict new phenomena, beyond SM. Additional spatial dimensions, essential for formulating quantum gravity in the context of string theory, have been proposed as a solution to the SM hierarchy problem. Arkani-Hamed, Dimopoulos, Dvali (ADD) model the graviton can modify the Drell Yan production.

Predictions for  $n > 3$  depend on one parameter  $\Lambda$

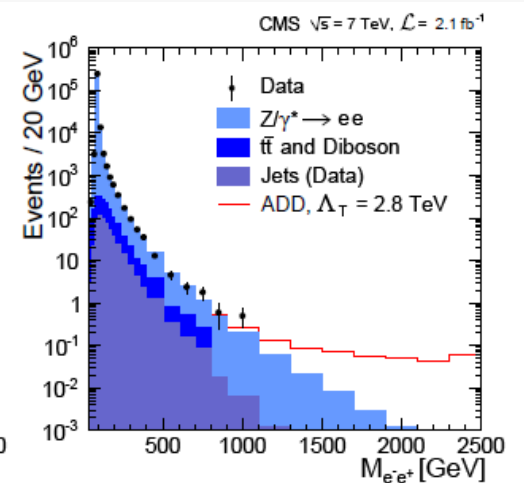
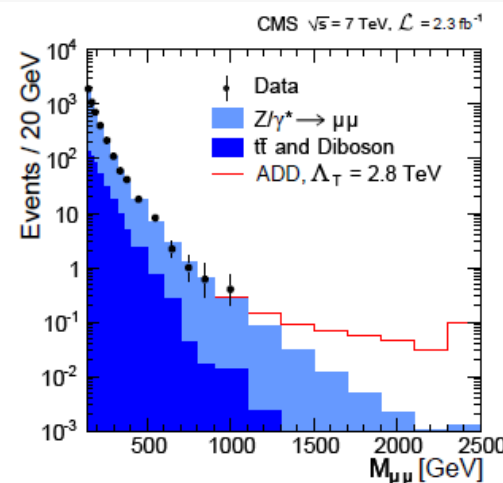
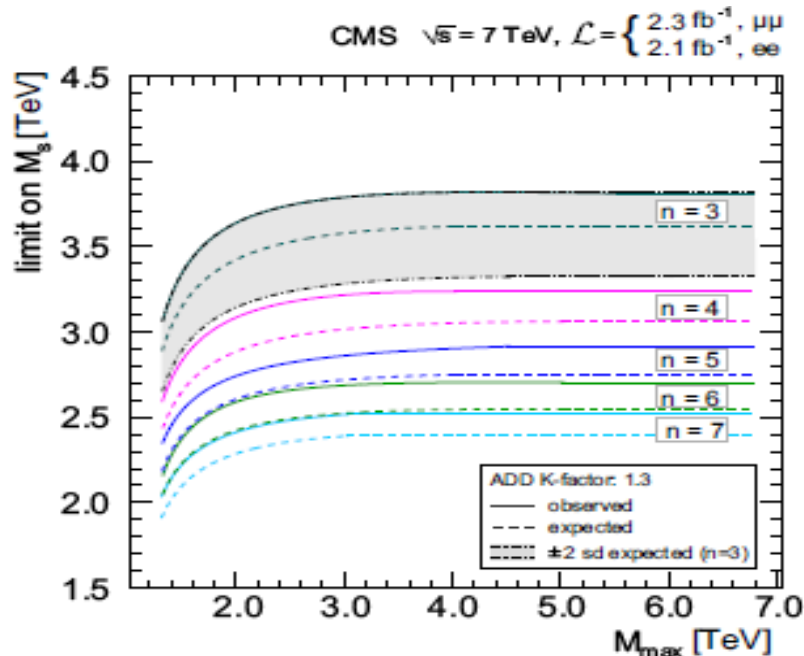

$M_s$  = effective Planck scale in ADD model

$$M_{\text{max}} = \max \sqrt{s}$$

# Di-jets Final States

Selects events with two high  $P_{\perp}$  jets  
 Look for bumps in  $M_{jj}$  cross section

Excited quarks:  $q^* \rightarrow qg$

$m(q^*) > 2.99$  TeV

Axigluon  $m(A) > 3.32$  TeV

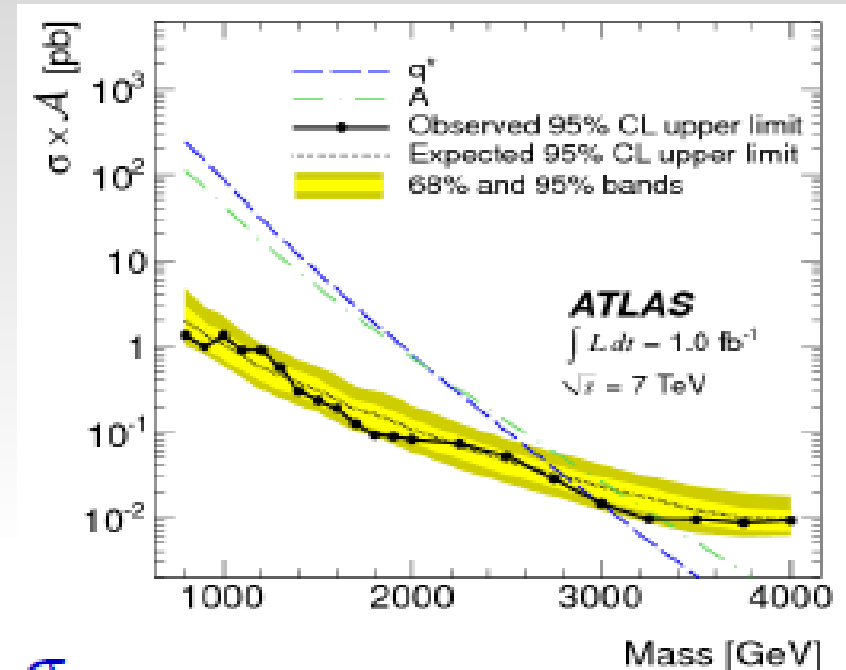
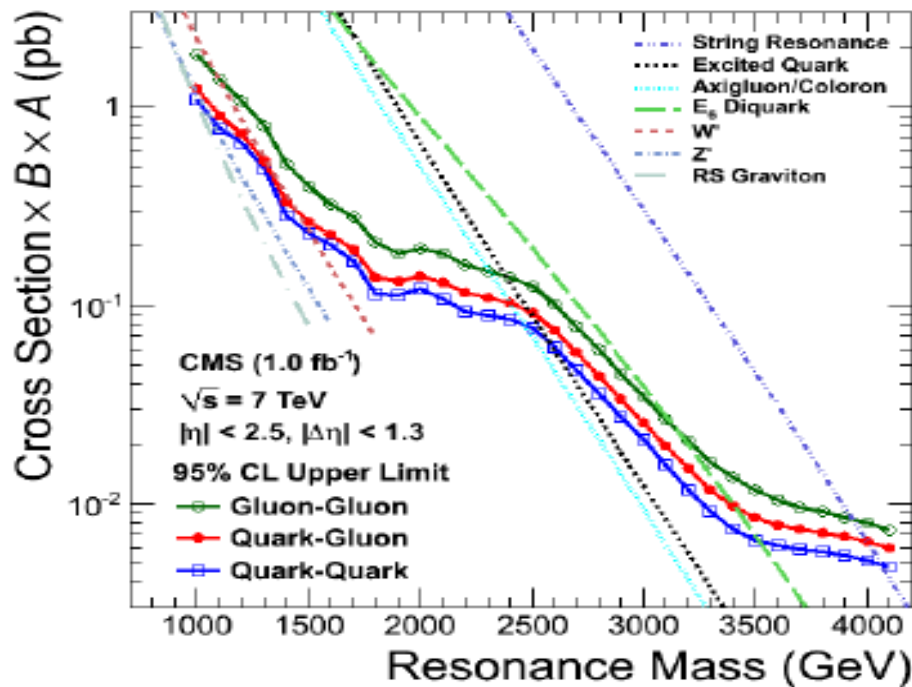

String resonance  $m > 4$  TeV

Heavy Bosons  $m_{W'} > 1.5$  TeV



# Leptoquarks searches

Leptoquarks are proposed as link among quarks and leptons, with fractionally-charged color-triplet bosons carrying both lepton and baryon quantum numbers. Leptoquarks appear in a wide range of theories including  $SU(5)$  grand unification, superstrings,  $SU(4)$  Pati-Salam, and compositeness models.

Leptoquark couple only with one generation to avoid flavor violation

1<sup>st</sup> Generation

$$LQ \bar{L}Q \rightarrow e e^+ q \bar{q}$$

$$LQ \bar{L}Q \rightarrow e^+ \nu_e q q_i$$

$$LQ \bar{L}Q \rightarrow \nu_e \nu_e q \bar{q}$$

2<sup>nd</sup> Generation

$$LQ \bar{L}Q \rightarrow \mu^+ \mu^- q \bar{q}$$

$$LQ \bar{L}Q \rightarrow \mu^+ \nu_\mu q q_i$$

$$LQ \bar{L}Q \rightarrow \nu_\mu \nu_\mu q \bar{q}$$

3<sup>rd</sup> Generation

$$LQ \bar{L}Q \rightarrow \tau^+ \tau^- q \bar{q}$$

$$LQ \bar{L}Q \rightarrow \tau^+ \nu q q_i$$

$$LQ \bar{L}Q \rightarrow \nu_\tau \nu_\tau q \bar{q}$$

Final states with:

-jets

-leptons

-neutrinos (MET)

# Leptoquarks searches cont'd

First generation:

- \* di-electrons + jets
- \* electron + MET + jets
- \* MET + jets

Main background:

W+jets, top, Z+jets

Second generation:

- \* di-muons + jets
- \* muon + MET + jets
- \* MET + jets

Main background:

W+jets, top, Z+jets

Third generation:

- \* di-taus + jets
- \* tau + MET + jets
- \* MET + jets

Main background:

W+jets, Z, QCD

# First Generation Leptoquarks Results

$\beta$  is the branching ratio  $LQ \rightarrow \ell q$   
 $1-\beta$  is the branching ratio  $LQ \rightarrow \nu q$

Atlas :

final states with  $eejj$   $evjj$

Limits:

- $m_{LQ} > 660$  GeV for  $\beta=1$
- $m_{LQ} > 607$  GeV for  $\beta=0.5$

Phys. Lett. B 709, 158 (2012)

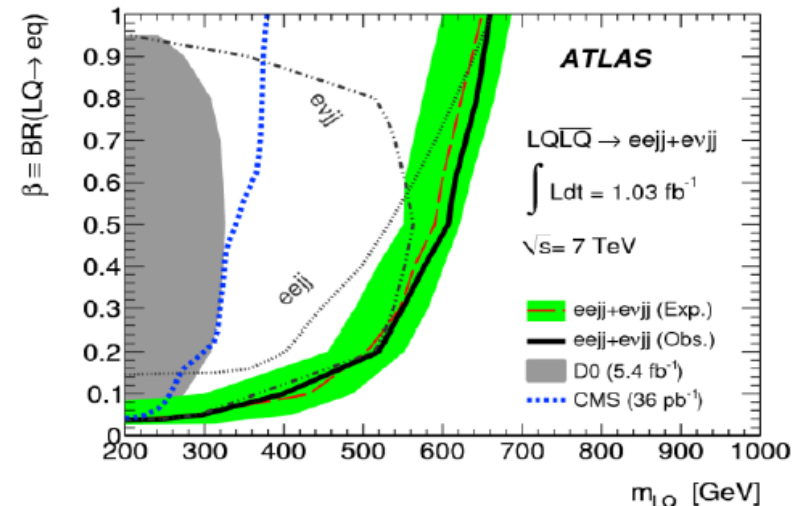
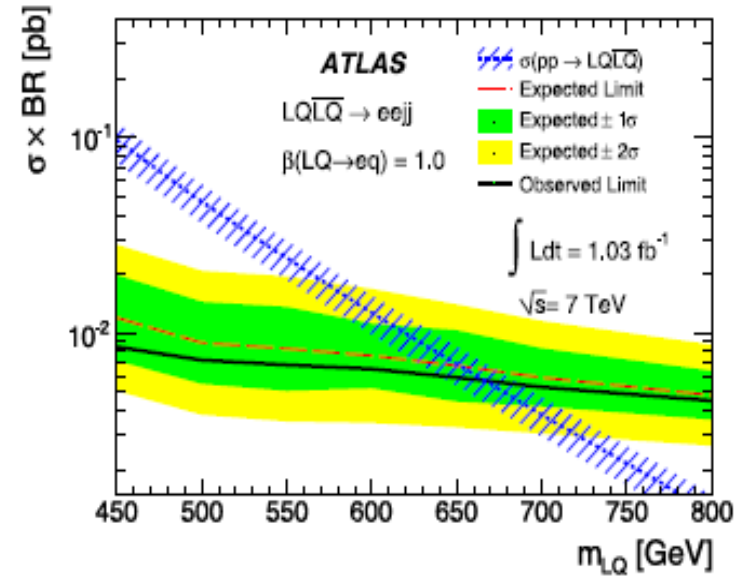

# Second Generation Leptoquarks Results

Final states with  $\mu\mu jj$   $\mu\nu jj$

CMS

Limits:

$-m_{LQ} > 632 \text{ GeV}$  for  $\beta=1$

$-m_{LQ} > 523 \text{ GeV}$  for  $\beta=0.5$

Atlas

Limits:

$-m_{LQ} > 685 \text{ GeV}$  for  $\beta=1$

$-m_{LQ} > 594 \text{ GeV}$  for  $\beta=0.5$

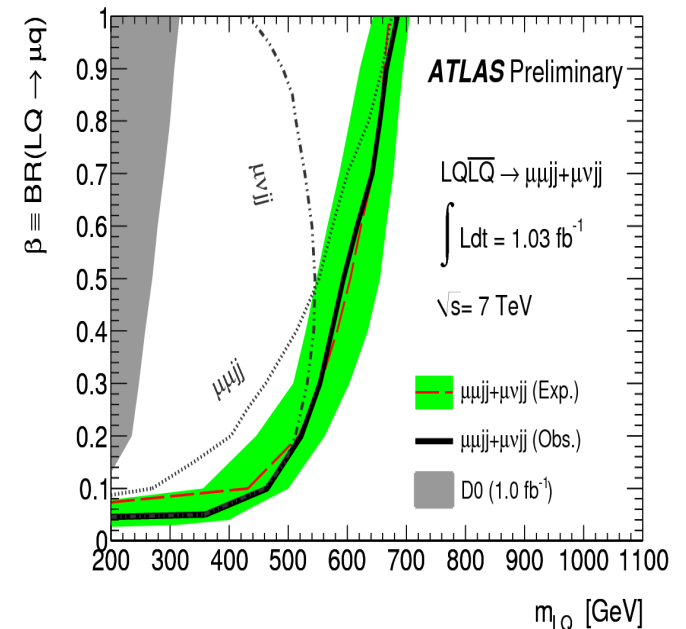
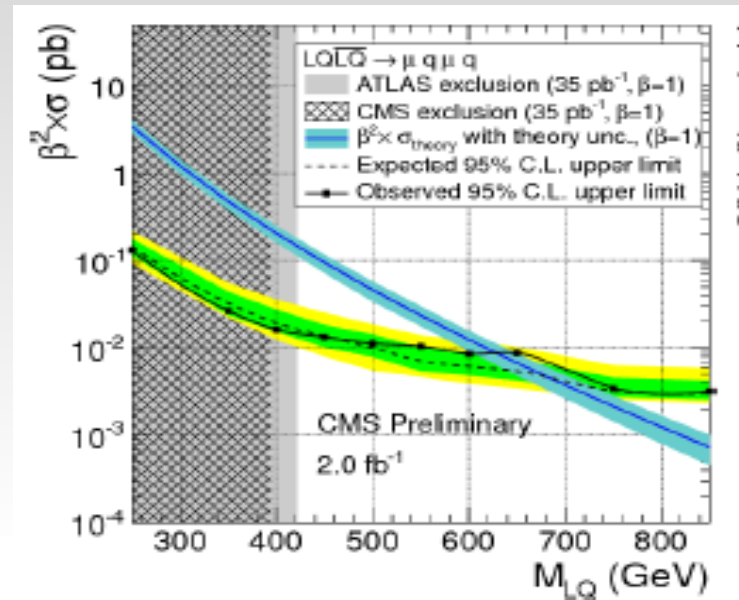

# Third Generation Leptoquarks Results

CMS :

final states with  $\nu_{\tau} \nu_{\tau} b b$

Use variables optimized to search for heavy mass particles

Limits:

$-m_{LQ} > 350 \text{ GeV}$  for  $\beta=1$

